

# ASTRO

*State-of-the-Art Instruments*



# PHYSICS

*for Discriminating Astronomers*

## 1600GTO German Equatorial Mount with GTOCP4 Servo Motor Drive

Mounts Shipped  
Starting in  
July 2016



Keypad Optional

Astro-Physics, Inc.  
11250 Forest Hills Road  
Machesney Park, IL 61115  
Telephone: 815-282-1513  
Fax: 815-282-9847  
support@astro-physics.com  
www.astro-physics.com

# **ASTRO-PHYSICS**

## **1600GTO GERMAN EQUATORIAL WITH GTOCP4 SERVO MOTOR DRIVE**

ABOUT THIS MANUAL	3
1600GTO PARTS LIST	4
MECHANICAL SPECIFICATIONS	5
INTRODUCTION	6
Why Polar Alignment is Important	6
ASSEMBLY DIAGRAM	7
PLAN AHEAD AT HOME	8
Handy Tools to Have on Hand	8
AT YOUR OBSERVING SITE	8
Assemble Pier (purchased separately)	8
Attach Polar Axis Assembly to Pier	9
Latitude Adjustment for 1600GTO German Equatorial Mounts	10
Special 90 Degree Alt-Azimuth Position	11
ASSEMBLY INSTRUCTIONS	12
Assembly of R.A. and Dec. Axes	12
Assembly Procedure:	12
Disassembly procedure:	13
CABLE MANAGEMENT	14
Preparation	14
The Basics	14
The Specifics	14
Routing Cables if You Plan to Use the Cable Router Insert When Using the Polar Scope	15
Routing Cables if You Don't Plan to Use the Cable Router Insert	16
ATTACH MOUNTING PLATE	17
Fixed Mounting Plate Options	17
Losmandy D-Style Compatible Saddle Plates	18
Astro-Physics Dovetail Option	18
Side-by-Side Configurations with D-Style Saddles	19
Astro-Physics P-Style Compatible Saddle Plates	19
ATTACH COUNTERWEIGHT SHAFT AND COUNTERWEIGHTS	20
ATTACH MOUNTING RINGS AND SCOPE	20
UNDERSTANDING THE R.A. AND DEC. CLUTCH KNOBS	21
BALANCING THE TELESCOPE	22
Preliminary Balancing	22
Precision Balancing	22
Disengaging the Worm and Worm Wheel	22

ALTITUDE AND AZIMUTH ADJUSTMENTS – ROUGH POLAR ALIGNMENT	24
POLAR ALIGNMENT OPTIONS – FINE POLAR ALIGNMENT	25
Methods for fine polar alignment	25
Making Precise Altitude and Azimuth Adjustments	26
Fine Altitude Adjustment	26
Tips for Adjusting the Altitude	26
Fine Azimuth Adjustment	27
Precision-Adjust Rotating Pier Base with Azimuth Bearing	27
Using Software to Improve Pointing Accuracy	27
MISCELLANEOUS ITEMS	28
Bubble Level and Lanyard Post	28
Warning for Dec. Servo Cable	28
SLEWING YOUR MOUNT IN BELOW FREEZING TEMPERATURES	28
GEAR MESH IN THE 1600GTO	29
Checking and Adjusting the Gearboxes in R.A. and Dec.	29
MOUNT CARE, CLEANING AND MAINTENANCE	30
Care	30
Cleaning and Touch-up	30
Routine Mount Maintenance	30
TROUBLESHOOTING, TIPS AND SUPPORT	31
Troubleshooting and Tips	31
Additional Support	34
APPENDIX A: 1600GTO ABSOLUTE ENCODERS	35
Part numbers and description	35
What's Included in the Kit	35
Absolute Encoder Cable Connections	35
APAE Utility	36
APPENDIX B: DECLINATION AXIS BACKLASH TESTS	37
PulseGuide™	37
Dec Backlash Test 1	37
Dec Backlash Test 2	37
After Running Tests 1 and 2	38
Dec Backlash Test 3	38
MaxImDL™	38
Step 1	38
Step 2	38
Step 3	38
APPENDIX C: MOUNTING PLATE FASTENER CHART	39

# ASTRO-PHYSICS

## 1600GTO GERMAN EQUATORIAL WITH GTOCP4 SERVO MOTOR DRIVE

### ABOUT THIS MANUAL

This version of the 1600GTO Manual was prepared for the production run of mounts that began shipping in July of 2016. Most of the information in this manual is applicable to all 1600GTO mounts that have been produced.

You should also note that this manual is actually one component of a three document system. In the past, we had two manuals for each mount - one for the individual mount and another manual for the keypad that applied to all mounts. Starting in the summer of 2011, we further divided the mount manuals to allow us to present the GTO Servo Motor Drive System in greater detail. Like the Keypad Manual, the GTO Manual is universal to all mounts that use the Astro-Physics GTO Servo Motor Drive System with the GTOCP4 Servo Control Box. This 1600GTO Manual, on the other hand, will cover the 1600GTO's mechanical features and physical operations.

As always, we highly recommend the Technical Support Section of our Web site for the latest information and for future updated versions of this manual.

A final note and an apology to our friends in the southern hemisphere. Many of the instructions in this manual are written entirely from the point of view of those of us in the northern hemisphere. Since descriptive terms like left and right are meaningless without a defined point of reference, we tend to use east and west to avoid ambiguity. The east and west sides of a German equatorial mount are, of course, reversed in the southern hemisphere. At one point, our thought was to always use phrases like the following: "... on the east side (west side in the southern hemisphere) ..." This quickly became cumbersome and made the text more difficult to read. For simplicity, we decided to leave many of the explanations in their northern hemisphere framework. To our southern hemisphere friends: *We love you no less and apologize for this unintended slight.* We know, however, that you are all smart enough to make the necessary translation to "down under" appropriate instructions. Thank you for your understanding.

### PLEASE RECORD THE FOLLOWING INFORMATION FOR FUTURE REFERENCE

Mount Serial Number: \_\_\_\_\_

GTOCP4 Serial Number: \_\_\_\_\_

Keypad Serial Number: \_\_\_\_\_

Purchase Date: \_\_\_\_\_

# 1600GTO PARTS LIST

- 1 Polar Fork / Right Ascension Axis (R.A.) Assembly
- 1 Declination Axis (Dec.) Assembly
- 1 Dec. Top Plate (S1600DTP)
- 1 GTO Servo Control Box (GTOCP4)
- 1 19.5" x 1.875" Stainless Counterweight Shaft (M12601-D) with machined Safety Stop (M12676)
- 1 R.A. Cable Router Insert (M16145-A)
- 1 Mount to GTOCP4 Cable (CABGTOR19)
- 1 D.C. power cord set - 6' cable with power pole connectors (CABPP6), 18" cable with cigarette plug (CABPP18C) and 18" cable with ring connectors (CABPP18R) and clip (FPCLIP)
- 1 15' Straight-through Serial Cable (CABSER15)
- 1 Hex key Set
- 10 3/4" x 8" Velcro Cable tie wraps
- 1 CD containing: *PEMPro*™ v2 Software and *PulseGuide*™ Software (both written by Ray Gralak of Sirius Imaging) and PDFs of manuals
- Instruction Manuals and Registration Card
- Fasteners:
  - (4) 1/4-20 x 3/4" SHCS (for safety backup of dovetails)
  - (7) 5/16-18 x 5/8" SBHCS (pier adapter) (6 + 1 extra)
  - (7) 5/16" flat washers (pier adapter)

**In order to fully assemble your mount, you will need some of the following items sold separately. Many of these items will be discussed throughout these instructions.**

- **10" O.D. pier:** Astro-Physics has several heights and styles to choose from.
- **Counterweights:** 5 lb. (5SCWT), 10 lb. (10SCWT), 18 lb. (18SCWT), 24 lb. (24SCWT) and 30 lb. (30SCWT188) are available.
- **Regulated Power Supply (110V AC to 12V DC converter):** We offer two choices: 13.8-volt, 5-amp supply (PS138V5A) or 15-volt, 12-amp supply (PS15V12A). Both supplies are filtered and regulated. We recommend the 15-volt supply for heavier loads and colder weather. The mount should have its own power supply.
- **Portable rechargeable 12-volt battery pack:** Several sizes and types are available from a variety of vendors. Be sure that your battery pack can supply adequate power for an entire observing session! Please refer to power requirements under Features and Specifications on next page. We recommend having separate batteries – one for the mount and one or more for all other accessories: camera, computer, dew removers etc.

Several additional options are available:

- **Optional GTO Keypad controller** with 15' coiled cable. Hand-held computer to operate the mount without a PC and additional software.
- **9" Counterweight Shaft Extension (M12675):** For heavier loads.
- **Autoguiding accessories:** Various guiding configurations can take advantage of the 1600GTO's autoguider port. The autoguider port receptacle (RJ-11-6) uses the industry standard SBIG ST-4 wiring setup.
- **Pier accessory trays and support bars:** Accessory Tray (TRAY10) and/or Eyepiece Accessory Trays (TRAY10H) with Bi-Level (TRAYSB) or Single Level (TRAYSB1) Support Bars. Keep things close at hand.
- **1600 Flat Surface Adapter (1612FSA):** For attaching the 1600GTO to your own custom pier or tripod.
- **1600 Flat Surface Adapter with Flat Pier Plate (1612FSA-FP):** For attaching the 1600GTO to the Advanced Telescope System (ATS) pier, or to your own custom pier or tripod when a flat pier plate is needed.
- **Polar Alignment Scopes:** AP Right-Angle Polar Alignment Scope (RAPAS) and Losmandy Polar Alignment Scope (PASILL4-179) – Many users find a polar alignment scope useful for zeroing in on the pole quickly, particularly with telescopes that are not orthogonal to the mount.
- **Extension cable for keypad:** Please call Astro-Physics to obtain a quote on the length of extension cable you need.

For a complete listing of our 1600GTO accessories, visit our Web site – [www.astro-physics.com](http://www.astro-physics.com).



## MECHANICAL SPECIFICATIONS

Construction	All CNC machined aluminum bar stock, stainless steel, brass; stainless steel fasteners
Finishing and Assembly	Every part is hand finished and inspected. All assembly is done by hand, by highly skilled mount assembly staff.
Worm wheel - R.A. & DEC.	10.3" (262 mm), 225 tooth aluminum
Worm gear - R.A. & Dec.	1.22" (31 mm) diameter, special low-wear alloy
Axis shaft - R.A. & Dec.	3.74" (95 mm) diameter
Shaft axis bearings - R.A. & Dec.	5.71" (145 mm) diameter
Latitude range	0 to 78 degrees and 90 degrees for Alt-Az
Azimuth adjustment	Approximately 13 degrees ( $\pm$ 6.5 degrees from center)
Counterweight shaft	1.875" (47.6 mm) diameter x 19.5" (495 mm) long [18.5" (470 mm) usable length], incl. large machined safety stop knob. Optional 9" (229 mm) shaft extension available.
Weight of mount	Total: 114 lb.. (51.8 kg) R.A. axis / polar fork: 58.5 lb.. (26.6 kg) Dec. axis: 38.5 lb.. (17.5 kg) Dec. top plate 3.0 lb.. (1.4 kg) Counterweight shaft: 14 lb.. (6.4 kg)
Capacity of mount	Approximately 220 lb.. (100 kg) scope and accessories (not including counterweights), depending on length. Recommended for refractors up to 250 mm, 18-20" Cassegrains, Ritchey-Chretien and CDKs. These are only guidelines. Some telescopes are very long for their weight or heavy for their size and will require a larger mount. Remember also that imaging requirements are more rigid than visual observation.
Instrument mounting interface	Reference the "Attach Mounting Plate" section of the manual.
Pier adapter base	9.775" (248.3 mm) diameter. The base is an integral part of the mount and azimuth adjuster.

***For a complete listing of the servo control, power, and periodic error specifications, please see the GTO Servo Drive System Manual.***



# INTRODUCTION

The 1600 German equatorial was designed to meet the needs of the advanced observer who requires a mount with maximum strength and rigidity and minimum weight. The excess material in both axes has been carved out while retaining a heavily ribbed structure for internal strength and rigidity. A unique dovetail was machined into the mating surfaces of the R.A. and Dec. axes and also between the Dec. axis and the Dec. axis Top Plate. This feature allows quick and easy assembly in the field without any tools.

The DC servo motor drive with GTO computer system, the optional keypad with its digital display screen, and the included AP V2 ASCOM Driver, *PulseGuide*™ and *PEMPro*™ v.2.x software all combine to offer extraordinary sophistication for today's observer. Whether you enjoy visual astronomy exclusively or plan an aggressive astrophotography or CCD imaging program, this mount will allow you to maximize your night out under the stars.

The advanced keypad features allow you to slew automatically to objects in a wide range of databases as well as any R.A./Dec. or Alt./Az. coordinate. A large selection of common names for stars and other objects makes your selection a snap. The rapid slew rate of 5 degrees per second (1200x) allows you to locate objects very quickly and accurately. You will be very pleased with the intuitive operation of this keypad. There are no complicated sequences of keystrokes to remember. It is so easy to use that even if you don't use it for a few months, you will feel at home with the keypad very quickly.

The keypad is only one way of controlling the versatile Astro-Physics GTO Servo System. From its very conception, the servo controller was designed to work with any software that was written to use our published command set. We do not lock you into any proprietary software or mandatory "additional" equipment. To increase the versatility of all our mounts, we have developed and now fully support a V2 ASCOM Driver for use with all ASCOM client software.

As mentioned above, we also include *PulseGuide*™ mount control / utility software and a full version of *PEMPro*™ (Periodic Error Management Professional) v.2.x (latest version) for you to enhance your control and performance options. As an added bonus, all 1600GTO mounts will come pre-loaded with the custom-fitted *PEMPro*™ corrections from our extensive individual testing that is performed on each and every mount. While the native periodic error of your 1600GTO will be 5 arcseconds or less, you can reduce it even further to maximize performance without auto-guiding. These software control products are detailed later in the manual.

In addition to everything outlined above, the 1600GTO's control and performance options will be greatly enhanced by the Astro-Physics Command Center (APCC). APCC fully addresses all the capabilities of the 1600GTO, and adds enhancements not currently available in the keypad or in any other software.

The 1600 is equally at home in a permanent observatory or as a portable mounting for remote star parties thanks to the ease with which the two axes come apart. This is the perfect mount for a large refractor, Newtonian, Cassegrain or astrograph.

In order to maximize your pleasure on your first night out, we recommend that you familiarize yourself with the assembly and basic operation of the mount indoors. The temperature will be comfortable, the mosquitoes at bay, and you'll have enough light to see the illustrations and read the manual. Please take particular note of counterbalancing, use of the clutches and operation of the keypad controller.

## Why Polar Alignment is Important

Polar alignment permits accurate R.A. movement in order to compensate for the Earth's rotation.

If you were to take a long exposure photograph with Polaris (often called the north star) in the center of the field, you would discover that all stars seem to revolve around Polaris. This effect is due to the rotation of the earth on its axis. Motor-driven equatorial mounts were designed to compensate for the earth's rotation by moving the telescope at the same rate and opposite to the earth's rotation. When the polar axis of the telescope is pointed at the celestial pole (polar aligned) as shown in the diagram at right, the mount will follow (track) the motions of the sun, moon, planets and stars. As a result, the object that you are observing will appear motionless as you observe through the eyepiece or take astrophotos.

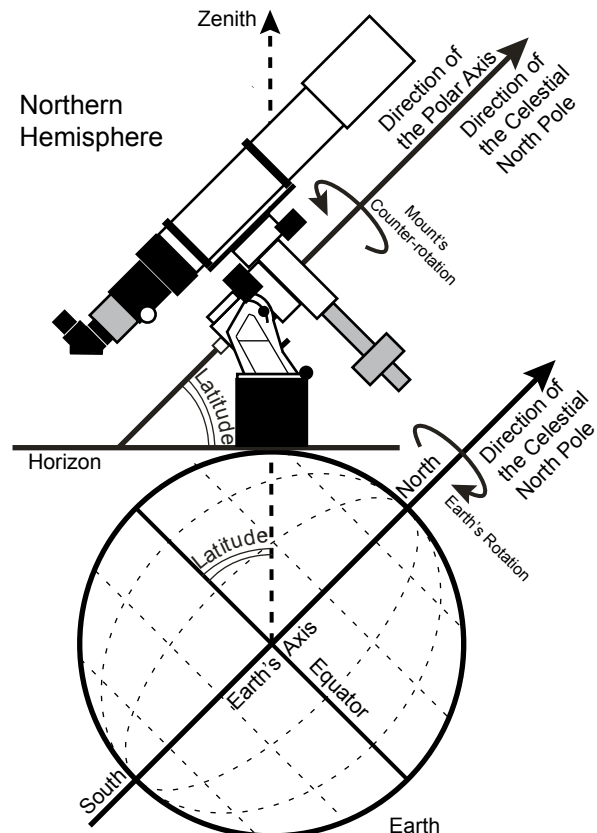

# ASSEMBLY DIAGRAM

The following terms and abbreviations are used interchangeably in these instructions:

Polar axis = right ascension axis = R.A. axis = R.A. housing

Declination axis = Dec. axis = Dec. housing

Please read all instructions before attempting to set up your 1600GTO mount. The model 1600GTO is very rugged; however, like any precision instrument, it can be damaged by improper handling. Please refer to the diagram below for an illustration of the mount. The parts are labelled so that we can establish common terminology. Pay particular attention to the section regarding joining and separating the R.A. and Dec. axes as this is unique to this mount. It is important to note the need to connect and disconnect the Dec. motor power / communication cable internally.

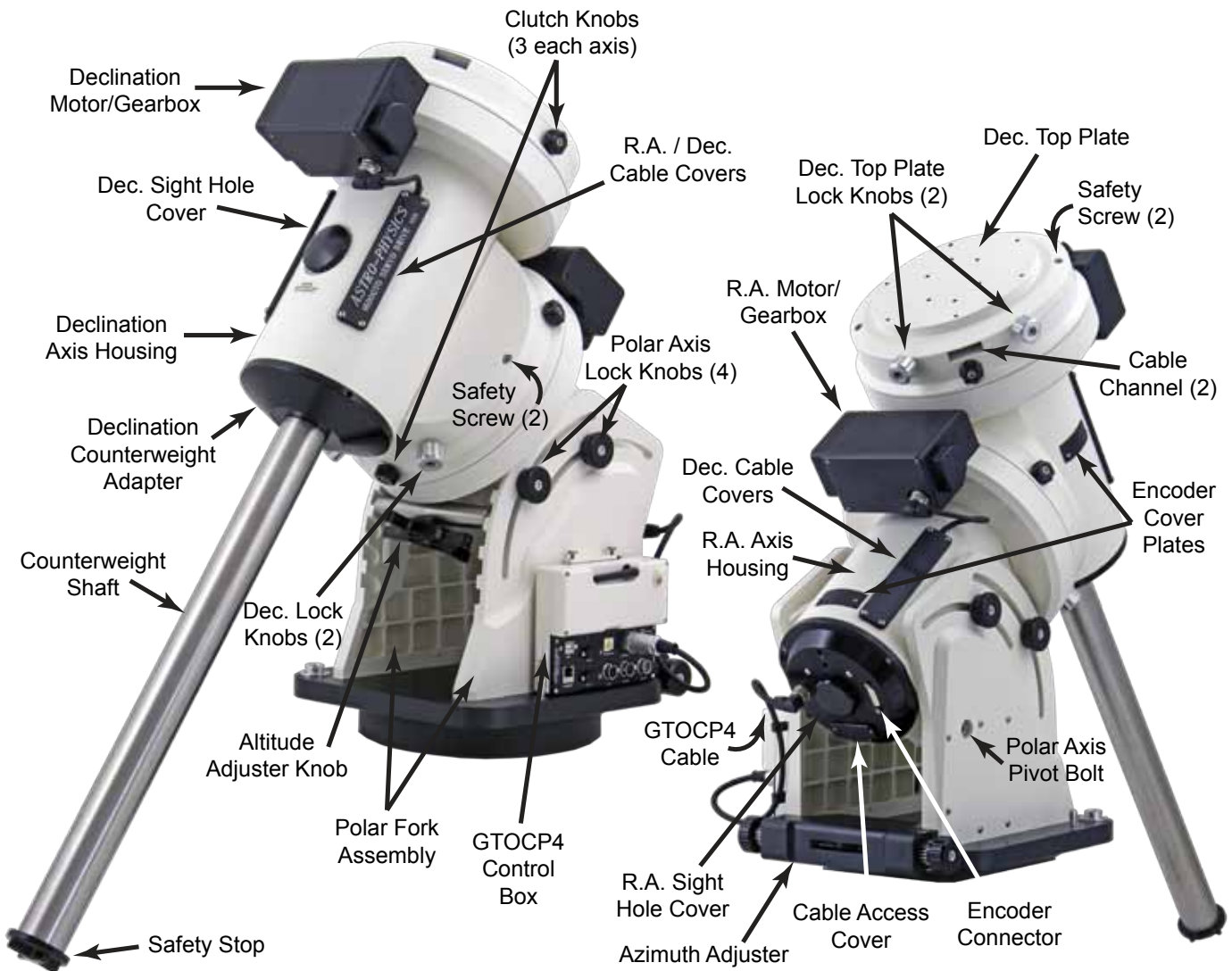



# PLAN AHEAD AT HOME

## *Handy Tools to Have on Hand*

### ***In Your Accessory or Tool Box:***

- Small torpedo level to level your scope when using the handy reference park positions, particularly during the daytime polar alignment routine outlined in your Keypad manual.
- Compass - Don't forget to know your magnetic offset when using a compass (there can be a large difference).
- Documentation – Physical copies of your mount, control box and keypad (if you have one) manuals as well as any other documentation that you received with your mount (or control box) or that you find in the Technical Support section of our website that may be useful.

### ***On Your Smart Phone:***

For the upmost of convenience, the following items can be downloaded to your smart phone, which you are likely carry with you everywhere.

- App(s) that allow your phone to be used as a level, inclinometer and compass. Don't forget to know your magnetic offset when using a compass since there can be a large difference.
- Astro-Physics Polar Alignment App – The longitude and latitude of your current site will display. Apps are available for iOS, Android and Windows.
- Download PDFs of all relevant and recent documents from the Technical Support Section of our website or you can link to our website if you have service at your observing site.

# AT YOUR OBSERVING SITE

## ***Assemble Pier (purchased separately)***

Begin by assembling the portable pier at the desired observing location. Take note which direction is north. (These instructions are for the Astro-Physics Portable Piers. For other piers, please follow the manufacturer's instructions.)

1. Slide the three legs onto the nubs of the base and rotate the assembly so that one of the legs points toward north (or toward the south if in the southern hemisphere).
2. Place the pier post on the base, orienting the eyelets for attaching the turnbuckles directly above each leg.
3. Attach the tension rods. The turnbuckles should be drawn tight until the whole assembly is stiff enough to support your weight without movement.

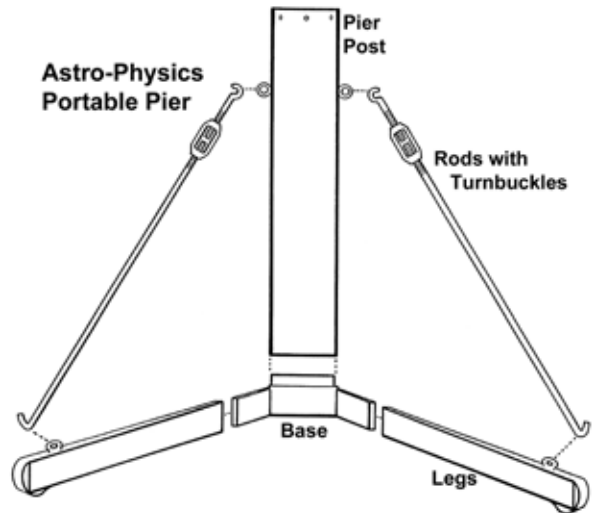

## Attach Polar Axis Assembly to Pier

In order to track the motion of astronomical objects, the Polar Axis must be positioned so that an imaginary line drawn through the center of the axis points toward the celestial pole. Refer to the diagram at the front of this manual for a graphical representation. At this stage of the assembly process, you want to position the pier so that it points roughly north.

1. **Prior to mounting the Polar Axis.** Adjust the Azimuth Adjuster so that the Azimuth Adjuster Block is centered. This will allow adjustability when it comes time to polar align the mount.
2. **Orient the pier.** Set up your pier so that the counterweight shaft is oriented above the north pier leg. It is important when using a portable pier to face one leg to the north so that the offset weight of the counterweight shaft and counterweights do not create an unstable balance.
3. **Set the R.A. Axis in place.** Carefully set the 1600GTO Right Ascension Axis / Polar Fork assembly into the open top of your pier, or into the 1600 Flat Surface Adapter (1612FSA), if you are using one. Unless you are quite strong, it is ideal to have two people involved in the operation of lifting and stabilizing the assembly as it is positioned into the pier or 1612FSA.
4. **Line up the Pier base.** If the side thru-holes in the pier or 1612FSA are not perfectly lined up with the tapped holes in the mount's Pier Adapter base, rotate the mount, noting that the azimuth adjuster knobs should be locked to the adjuster block. Otherwise, the base will rotate making it difficult to line up the holes.
5. **Secure the R.A. Axis to the pier.** When you have the holes lined up, fasten the mount to the pier top or to the Flat Surface Adapter using six 5/16-18 X 5/8" socket button head cap screws and 5/16 flat washers. Note that the washers have a sharp edged side and a softly rounded side. Be sure that the rounded side faces the paint or anodizing of the pier so that no marring of the finish occurs. Be sure to start all six cap screws (with their washers) before tightening any of them. Then, snug all six cap screws down before finally tightening them all securely.
6. **Level the mount.** Although it is not important that a German equatorial mount be level to achieve polar alignment, it does make it easier in that an adjustment to altitude or azimuth affects only the direction to which you are making the adjustment. If the mount is not level, you will be able to achieve alignment, but when you make an adjustment to azimuth, for example, you are actually making an adjustment to both directions when out of level. Note that if you are using the Right-Angle Polar Scope, it is required to be level in the east-west direction in order to achieve accurate polar alignment. Level the mount...you'll be ahead in the game!

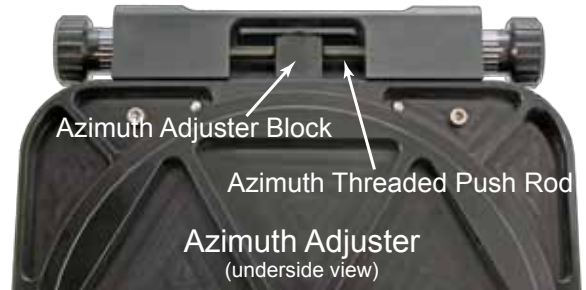

**Special note: It is a very good idea to include a small torpedo level and a compass in your accessory carry box, along with your other tools, when setting up portably. Modern cell phones, such as the iPhone, have Apps available that allow the phone to be used as a level, an inclinometer and a compass.**

## Latitude Adjustment for 1600GTO German Equatorial Mounts

The 1600 mount accommodates a latitude range from 0 to 78 degrees and 90 degrees. The Altitude Adjuster Bar allows for gross latitude ranges, while the Adjustment Knob is used to provide the precision adjustments when polar aligning. The Altitude Adjuster Bar is positioned into one of nine slots which provide an overlapping latitude range.

This altitude bar is very convenient when travelling to remote sites, as it allows you to transport your mount in the more compact, zero-latitude position. You can change to your remote site's latitude in one quick motion of the altitude bar.

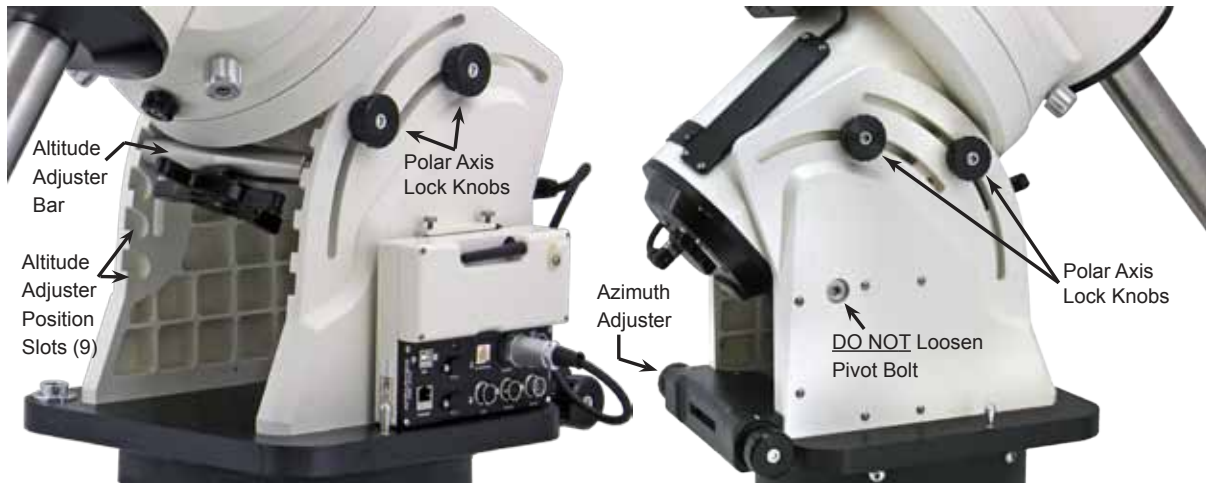

### How to change the position of the Altitude Adjuster Bar

1. Use only the R.A. axis. DO NOT attempt to make these adjustments with the declination axis in place and certainly not with an instrument fully mounted.
2. Loosen all four Altitude Lock Knobs about 1 turn.
3. The mount's Polar Axis is held in place between the two side plates of the Polar Fork. The axis pivots on custom shoulder bolts located towards the rear of each side plate. These bolts should not be loosened when making altitude changes to the mount.
4. Tilt the R.A. axis upwards and hand tighten the lock knobs so that the axis does not drop while you are repositioning the Altitude Adjuster Bar.
5. Note that the Altitude Adjuster Knob is attached to a threaded rod that travels through the Altitude Adjuster Bar. Turn the knob so that you see about half of the threaded rod protruding from both sides of the Altitude Adjuster Bar. This will allow you to move the mount fully within the altitude range. The slots are positioned at 9 degree increments and the threaded rod has 10 degrees of travel. They represent the following altitudes:
  - a) Slot 1 - 0-10° center: 5°
  - b) Slot 2 - 10-20° center: 15°
  - c) Slot 3 - 19-29° center: 24°
  - d) Slot 4 - 28-38° center: 33°
  - e) Slot 5 - 37-47° center: 42°
  - f) Slot 6 - 46-56° center: 51°
  - g) Slot 7 - 55-65° center: 60°
  - h) Slot 8 - 64-74° center: 69°
  - i) Slot 9 - 73-78° Note - it is necessary to remove the Lock Knobs and shift the mount into its 90° position in order to utilize this upper slot. Once done, lower the axis and restore the knobs.
6. Shift the Altitude Adjuster Bar into the correct slotted position. Note that the re-positioning is done so quickly and easily that trial and error positioning is inconsequential. There is a degree scale on each Polar Fork with a corresponding indicator line on the back of the worm wheel housing to assist you. (See photo at right.)

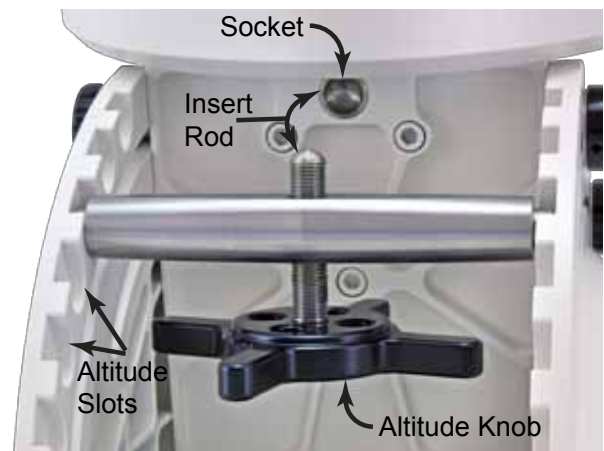

- Note that the threaded rod has a rounded end. Also observe that the underside of the R.A. axis has an inset socket. When you loosen the Altitude Lock Knobs and lower the polar axis be sure that the rod comes to rest fully seated in this socket. A little wiggle of the adjuster knob will ensure its proper seating.
- Turn the Altitude Adjustment Knob to raise or lower the Polar Axis to your approximate observing latitude (note the previously mentioned altitude lines on the side). Tighten the altitude locking knobs with finger pressure only. You do not need to tighten with the hex key.
- Later, as you adjust the mount's altitude when polar aligning, you should always make the final adjustments pushing upwards. Additionally, the locking knobs should be increasingly tightened as the final adjustments are made.



**Recommendation:** Rough polar positioning of the mount and pier should be done with the R.A. axis only since you will be making major adjustments to level the mount, aim it north and set the elevation. The remainder of the mount, telescope and counterweights will add considerable weight and require more effort when positioning. Later, you will do your actual polar alignment with telescope and counterweights attached, but the adjustments will be comparatively small and within the range of the altitude and azimuth fine adjustments. An inclinometer and a compass adjusted for magnetic declination at your location (or these functions on a smart phone App) are recommended.

## Special 90 Degree Alt-Azimuth Position

One of the unique design features of the 1600GTO mount is its ability to be placed into a 90° Alt-Azimuth position. This allows specialized functionality for research applications, as well as terrestrial viewing. In order to achieve maximum stability, it is important to maintain the center of gravity directly above the pier. This requires that the R.A. axis be reversed in the polar forks. The change over is outlined below in illustrations and description. **Note: This axis reversal must be done by two people...one to hold and reverse the axis and the other to remove and replace the bolts.**

- Remove telescopes and counterweights before beginning this orientation change. It is also necessary to separate the Dec. axis so that you are only working with the R.A. axis and forks.
- Remove all four Altitude Lock Knobs.
- Tilt the axis upward to its maximum balanced position and remove the Altitude Adjuster Bar and set aside. The axis must be held in place as there is no way to secure it.
- While one person holds the R.A. axis, have the other person remove the two shoulder bolts that are the Pivot Bolts for the axis. Remember that the full weight of the axis will need to be supported.
- Lift the axis straight up and out of the polar forks. Walk around to the other side of the mount so that the R.A. axis can then be lowered back into place, but now facing the other way.
- Align the Pivot Bolts with their respective threaded holes and screw into place. Do not tighten them until both bolts have been fully threaded and the axis rotated slightly back and forth to ensure that it is properly seated. Now tighten the bolts fully.
- Replace the four Altitude Lock Knobs. Notice that they will all be in the lower channel. Two of the knobs are placed into the available threaded holes that were previously unused. Use a bubble level to position the axis and secure the knobs tightly using a 1/4" hex key. You now have an Alt-Azimuth mount.

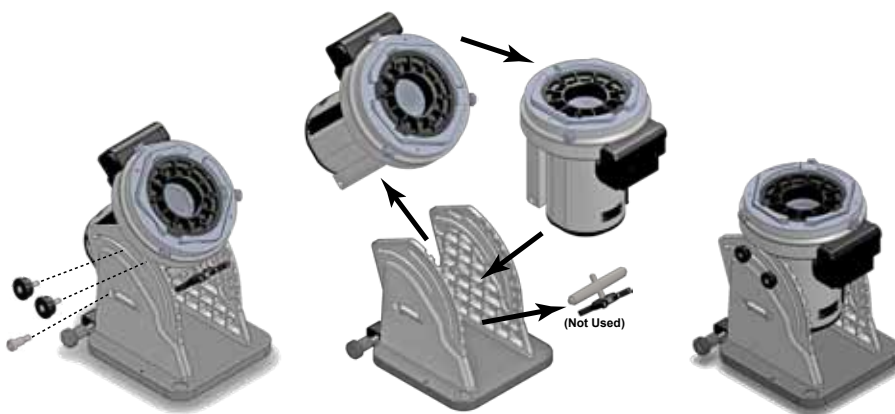

**Important Note:** We do not offer software for the 1600GTO mount configured in the Alt-azimuth mode at this time. It will be necessary for you to write your own command protocol. However, it can be used manually via button moves.

# ASSEMBLY INSTRUCTIONS

## Assembly of R.A. and Dec. Axes

One of the many features of the 1600GTO mount is internal wiring. Internal wiring adds protection and convenience. It eliminates many of the concerns, such as cable-snags and excess dew exposure to electrical parts, when the telescope is in use both in the backyard and at remote sites.

Much of the wiring is factory installed and not of concern to the user. However, the exception is the Dec. servo connection. It is necessary to attach the Dec. Servo Cable to its connector when joining the Dec. and R.A. axes. It is equally important to remember to detach the connection when separating the mounts two axes. Otherwise, damage could occur to the internal socket / circuit board or the Dec. axis could be pulled from your hands as you start to walk away.

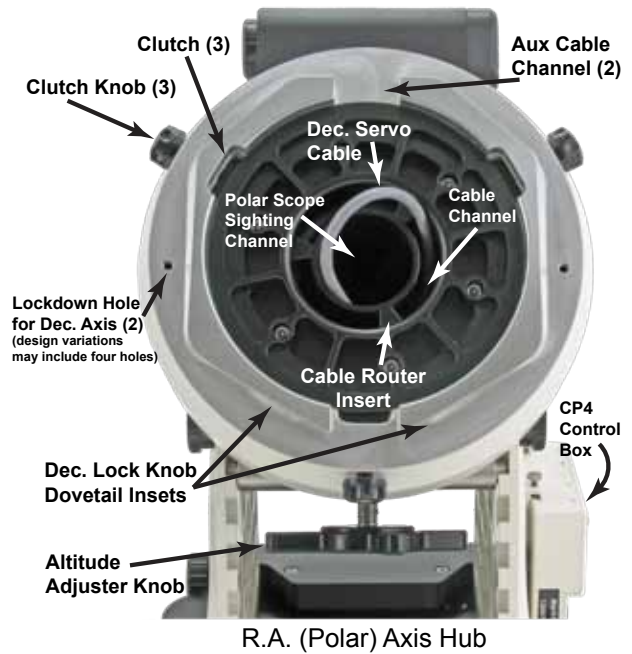

## Assembly Procedure:

**This section assumes that you are only running the motor cables through the mount. If you plan to run more cables, please read the next section entitled “Cable Management” before proceeding.**

1. Ensure that the R.A. (polar) axis is securely attached to its pier before proceeding.
2. You will notice that the Dec. Servo Cable routes through the R.A. axis. There is also a removable Cable Router Insert (seen at right) provided with the mount which serves the purpose of keeping any internal cables out of the light path of the polar scope. If you will not be using a polar scope, then you have the option of not using the cable router. Position the Dec. Servo Cable along the side of the insert and loop it back into the center of the insert. This will keep the cable out of the way when attaching the Dec. axis to the R.A. axis.



3. Rotate the R.A. axis to the position shown in the illustration with the two clutches at the top and the single clutch at the bottom. Note that the auxiliary cable channels line up vertically and that the Dec. locking knob dovetail insets are at the bottom.



4. During shipment, the Dec. axis lock knobs will be fully screwed into the Dec. axis. You will need to back these out (approximately 8+ turns) until the tip is fully retracted (the knob is removed with approximately 21 turns).

5. Position the Dec. axis above the R.A. axis (as illustrated with the image to the left). Then hook the top of the dovetails of the two axes together and tilt the axis into place while giving a light wiggle so as to properly seat them (shown by arrow “A”).

6. When the Dec. axis is fully seated, hand tighten the two locking knobs; then use a hex key to give the knobs an extra eighth turn for tightness. (Hint: It is not necessary to tighten these knobs as if they were the lug nuts on the wheel of a car.)

7. There are two 1/4” counter-bored holes (one on each side) on the front of the Dec. axis. Insert a 1/4-20 x 3/4” socket head cap screw into each of the holes and tighten. **It is important that you tighten the locking knobs fully before adding these screws, so that the dovetail of the Dec. axis is properly seated.** These provide additional security and rigidity for the heavier capacity of the mount.

8. Remove the Dec. Counterweight Adapter by unscrewing it. If it is too tight to turn by hand, you may insert a hex key into one of the two holes at the side of the adapter in order to gain leverage.



9. Reach inside the axis and retrieve the Dec. Servo Cable that was inserted into the center of the R.A. axis Cable Router. Connect the cable to the connector box as shown in the illustration and tighten the retaining ring.
10. Replace the Dec. Counterweight Adapter.
11. Thread the counterweight shaft into the Dec. axis. Ensure that the plastic washer is in place on the threads of the shaft so that the shaft will be easier to remove later.



**Dec. Counterweight Adapter Removed**

***Disassembly procedure:***

1. Essentially, one reverses the assembly procedure. Start by removing the telescope, counterweights and counterweight shaft.
2. Remove the Dec. Counterweight Adapter by unscrewing it. If it is too tight to turn by hand, you may insert a hex key into one of the two holes at the side of the cap in order to gain leverage.
3. Reach inside the axis and disconnect the Dec. Servo Cable at the connector box as shown in the illustration (see above illustration). Tuck it back into the center of the R.A. axis for safety and to prevent damage.

**DO NOT FORGET to disconnect this cable before separating the axes!!!**

4. Replace the Dec. Counterweight Adapter.
5. Remove the 1/4-20 security screws from the lock-down holes (if they were used) and loosen the two Dec. axis locking knobs 8+ turns.
6. Separate the two axes as shown by letter “B” in the previous illustration.
7. For transport and storage, we recommend re-tightening the Dec. locking knobs.
8. Place the R.A. axis in the zero-degree altitude position for compact transport.



# CABLE MANAGEMENT

It has become more important than ever to find ways to manage cable routing. We now have the lure of imaging and with it the addition of accessories requiring power and computer connectivity. Apart from multiple dew heater cables, we now have CCD cameras, color filter wheels, camera rotators, motorized focusers, autoguiders, adaptive optics units and the list goes on... All these devices have power cables and USB or serial cables that need to be managed. To simply allow all these cables to dangle would make your telescope look as though it is having a very "bad hair day" and it would invite disaster. At the very least, dangling cables create flexure that results in bad star shapes in your images; at worst, they cause cable snags and damage to your equipment.

We have gone to great lengths in designing and engineering the 1600GTO mount to accommodate advanced cable management. This job was made more complicated by our philosophy that our mounts should be portable and the two axes need to be able to be separated for the ease of setup and transport by our customers. Since our mounts can be portable, we further added to our challenge by requiring the ability to use a polar alignment scope for speeding set up time and alignment accuracy. We have succeeded. The 1600GTO allows you to pass all your cables through the mount while maintaining a visual path for a polar scope. It is the most advanced cable management system on the market today.

## **Preparation**

**Think ahead!** The key to good cable routing is good preplanning. Every imaging setup is somewhat unique. The equipment is different and the selection of devices depends upon the type of imaging that interests you and the level to which you wish to take it. As systems become larger and more complicated, the greater the importance of preplanning and organizing. It is not as simple to add a cable later when it becomes necessary to remove a large and heavy systems in order to do so.

It is best to lay out your imaging system and connect all the wiring so that you have a good idea of which cables need to be routed through the mount. This can be done by spreading your devices on a table; they do not actually need to be set up on a telescope. This will also allow you to have an idea about cable length, if there are choices to be made. Once you have all your devices connected and know that you are not forgetting an important power cable or other critical necessity, you are set to begin the actual process of routing your cables.

You may wish to consider reducing the number of cables needed by running a single power cable up through the mount to a power distribution hub, such as a RIGRunner, on top of your instrument package. Similarly, you can run a single communication cable through the mount to a communication hub, such as an ICRON Ranger, located at the top. Using these hubs can simplify and improve the quality of your setup.

## **The Basics**

The 1600GTO mount has some very unique features that assist you with your cable management. Starting at the top of the mount, you notice that there is a removable Dec. Top Plate. This plate allows you to attach various dovetail saddles and specialty plates for the many, varied telescope systems to be found today. It is also removable via a unique and powerful dovetail system so that you have unobstructed access to the internal central routing core of the mount. The bottom of the Dec. axis also has a removable Counterweight Shaft Adapter that unscrews to allow access internally so that routing cables can be done more easily.

The R.A. axis has a clever Cable Router Insert which is removable. This insert serves the dual purpose of organizing the routing of cables while preserving a clear light path for the polar scope. In a permanent observatory setup, it is not necessary to use the insert, though it may certainly be left in place, as it will not restrict the number of cables that can be run. It is designed to be removable so that cables can more easily be routed through the mount and then replaced to secure the light path.

The final part of the internal cable routing system is the Cable Access at the bottom of the rear R.A. Plate. This access has a cover that is removable by undoing the two socket head cap screws securing it. Once removed, cables with connectors as large as RS-232 cables can be fed through the opening. It is always a good idea to feed the largest connectors through first before moving on to the smaller sizes. If you do not plan to use a polar scope, you have the additional option of routing the cables through the central opening.

## **The Specifics**

What follows are some more detailed instructions for installing your cable package into the 1600GTO. You will, of course, have to tailor the instructions for your own particular needs. These instructions are for the routing of auxiliary cables for cameras, dew heaters, focusers and other devices that are not a component of the 1600GTO. The mount's own cables are discussed earlier in this manual in the sections on mounting the declination axis. Use the Assembly Diagram found earlier in the manual to help identify the named parts below.

There are two options for running cables through the 1600GTO. If you have the mount set up permanently in an observatory and have no plans for the use of a polar scope, then you can choose to not use the cable router insert and can run your cables through the mount while the two axes are joined. This has the advantage of more easily adding a cable later by fishing it through the mount while assembled. If you will be using a polar scope for setting up portably or if you plan its use at any time while set up permanently, then you will need to run your cables through the R.A axis first.

We shall first discuss the procedure for routing cables with the anticipation of using a polar scope. This option hinges on the need for placing the wires through the R.A. axis and then placing the cable router insert. It is only possible to run cables with small connectors after the cable router is in place and it may present difficulties once the mount has been fully assembled and equipment in place. As one sees in the illustration of the R.A. Axis Hub, the Cable Router creates three narrow cable paths around the outside of the light path. However, the Cable Router Insert is easily removed and replaced in order to change existing cables or if you choose to add additional ones while the Dec. axis is detached.



### Routing Cables if You Plan to Use the Cable Router Insert When Using the Polar Scope

1. Start with the R.A. (polar) axis properly installed on your pier.
2. Remove the Cable Router Insert and set to the side for later use.
3. Remove the Cable Access Cover from the rear plate of the R.A. axis by unscrewing the two socket head cap screws. Store it in a safe place, as it will not be used while cables are routed through the mount.

Note: you may find it helpful to also remove the Polar Scope Adapter Cap in order to have more light and to better see what you're doing. Just remember not to accidentally run a cable through the polar scope opening (assuming that you plan to use the polar scope)!

4. Begin by feeding the cable with the largest connector from the front of the axis to the rear. You will need to finesse the cable through the rear Cable Access opening. If you are having trouble coaxing the connector through the opening, you can always use the electrician's trick of first snaking a length of cord or thick string through the cable channel by attaching it to the end of a straight wire or similar probe of sufficient length to pass through the axis. Continue feeding your cables through the cable channel. Note that if you have a number of cables to run, then it may be best to use the electricians trick and pull them all through at one time.

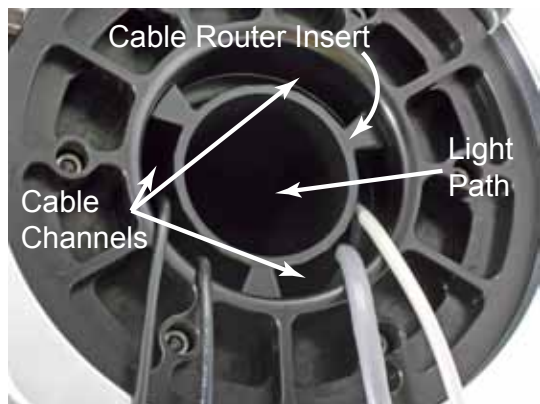

5. Insert the Cable Router into place while making sure that the installed cables are positioned in the channels. If you have a number of cables installed, then you may wish to divide them between the three channels, or separate power and communication cables.
6. Since you must still attach the Dec. Axis, you do not want to have the full length of the cables running through the R.A. axis, as the ends of the cables must be looped back into the center of the Cable Router as described in an earlier section referencing the Dec. motor / communication cable. Loop the ends of the cables into the center of the Cable Router. This is done in preparation of joining the Dec. and R.A. axes.

7. Attach the Dec. axis as described earlier and lock into place with the Lock Knobs. You will also want to place and tighten the two socket head screws that provide attachment security. Remove the Dec. Counterweight Adapter.

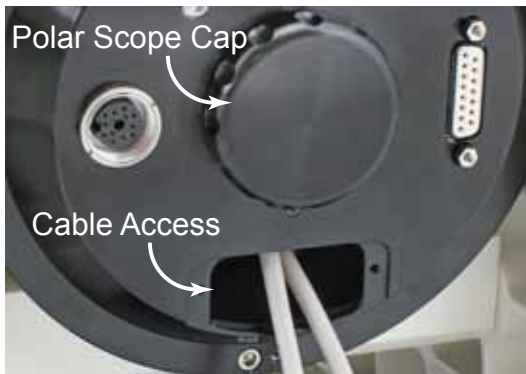

R.A. Rear Cover Plate

8. At this point you will unloop and route the Dec. power / communications cable as described in the R.A. / Dec. Assembly section. Attach it to its Dec. socket. Replace the Dec. Counterweight Adapter.

9. Next unloop and route the remaining cables up through the center of the Dec. axis. Cable lengths can be adjusted at this point.

Note: It may be advisable to make a tool for snagging the wires and pulling them up through the Dec. axis. This can be done by bending a wire clothes hanger (or similar) into a hook shape. Be sure to take care not to damage any of the interior wiring in the mount.

10. Decide which direction the cables should go (most will likely be towards the back of the scope, while some may best be towards the front) and direct them accordingly through either of the two cable channels found on the Dec. Axis Hub. This is a good time to further adjust the cable lengths as needed.

11. Attach the Dec. Top Plate to the axis and lock it in place by hand tightening the two lock knobs. You may then use a hex key to give the knobs an extra eighth turn for tightness. Do not overtighten. You may wish to place and tighten the two 1/4-20 x 3/4" socket head screws that provide additional attachment security. ***It is important that you tighten the lock knobs fully before adding these screws, so that the dovetail of the Dec. Top Plate is properly seated.***

## Routing Cables if You Don't Plan to Use the Cable Router Insert

1. Start with the R.A (polar) axis properly installed on your pier.
2. Remove the Cable Router Insert, if it was installed.
3. Attach the Dec. axis as described earlier and lock into place with the Lock Knobs. You will also want to place and tighten the two socket head screws that provide attachment security. Remove the Dec. Counterweight Adapter and connect the Dec. power / communications cable as previously described.
4. Remove the Cable Access Cover from the rear plate of the R.A. axis by unscrewing the two socket head cap screws. Store it in a safe place, as it will not be used while cables are routed through the mount.

Note: It may be advisable to make a tool for snagging the wires and pulling them up through the Dec. axis. This can be done by bending a wire clothes hanger (or similar) into a hook shape. Be sure to take care not to damage any of the interior wiring in the mount.

5. Begin by first feeding the cable with the largest connector through the Cable Access opening at the bottom rear of the R.A axis. You will need to finesse the cable through the opening and up through the center of the axis. If you are having trouble coaxing the connector through the axis, you can always use the electrician's trick of first snaking a length of cord or thick string through the cable channel by attaching it to the end of a straight wire or similar probe of sufficient length to pass through the axis. Continue feeding your cables through the cable channel. Note that if you have a number of cables to run, then it may be best to use the electrician's trick and pull them all through at one time.
6. Now is the time to utilize the "snagging tool" that you so laboriously created. It can be used to reach the cables as they peak out of the R.A. axis opening and you can then pull them up through the Dec. center. Alternatively, the electrician's trick of using a cord or thick string to pull the cables through the interior of the mount is a good one.

Note: This may be a good time to recommend routing a cord or thick string through the mount while routing the cables. It is convenient to have this option available to you should you ever wish to add a cable for a new device at a later date. It can simply be left in place until needed.

7. Decide which direction the cables should go (most will likely be towards the back of the scope, while some may best be towards the front) and direct them accordingly through either of the two cable channels found on the Dec. Axis Hub. This is a good time to further adjust the cable lengths as needed.
8. Attach the Dec. Top Plate to the axis and lock it in place by hand tightening the two lock knobs. You may then use a hex key to give the knobs an extra eighth turn for tightness. Do not overtighten. You may wish to place and tighten the two 1/4-20 x 3/4" socket head screws that provide additional attachment security. ***It is important that you tighten the lock knobs fully before adding these screws, so that the dovetail of the Dec. Top Plate is properly seated.***



Dec. Top Plate Removed



Dec. Top Plate in Place

# ATTACH MOUNTING PLATE

*(purchased separately)*

Take note of the hole-patterns available on the Declination Cap of the 1600GTO. Most of you will use either the outer six-hole bolt pattern or else the inner four-hole bolt pattern to attach your mounting plate. Some of the plates can use bolt holes from both the four and six hole-patterns. Please note that the mounting plates below are drawn at a smaller scale than the hub at right. The plates are relatively at scale with each other for comparison.

Several mounting plates (also called cradle or saddle plates) are available for the 1600 mount. If you own more than one instrument, you may need more than one plate. Follow the appropriate directions for the plate(s) that you have. The darkened holes represent those used for the 1600 mount.

## 1600GTO Dec. Top Plate Mounting Hole Pattern

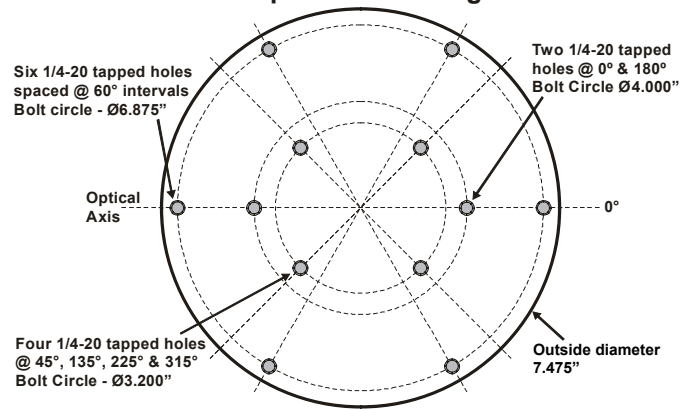

## Fixed Mounting Plate Options

### 18" Flat Mounting Plate (FP1800)

This plate is 18" long and 7.5" at its widest point in the center. The width of the plate tapers to 5.5" at each end. Four pairs of keyhole slots that measure 3.2" between centers are provided. The two inner pairs are 13.75" apart and the outer two pairs are 17" apart. You can drill additional holes to suit your needs. This plate also fits the 900 and 1200 German Equatorial.

Attach this plate with six 1/4-20 x 1" flat head socket cap screws.

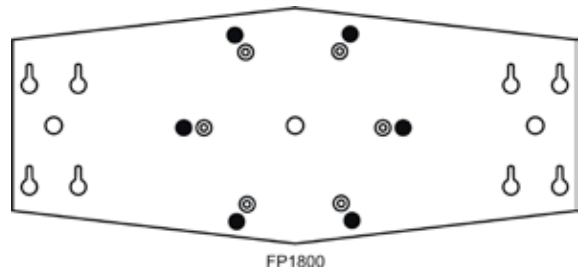

### 15" Ribbed Mounting Plate (1200RP15)

This plate is 14.75" long, 7.75" at its widest point, 5" at each end and 1" thick. The underside of the plate is carved into a ribbed pattern to maximize the strength and minimize the weight - 3 lb. A pair of keyhole slots that measure 3.2" between centers are provided at each end. The distance between the pairs is 13.75".

Attach this plate with six 1/4-20 x 3/4" socket head cap screws. Note that the plate is asymmetrical. In most cases, orient the plate so that the long end points toward the sky. You can also turn the plate in the other direction to balance your scope.

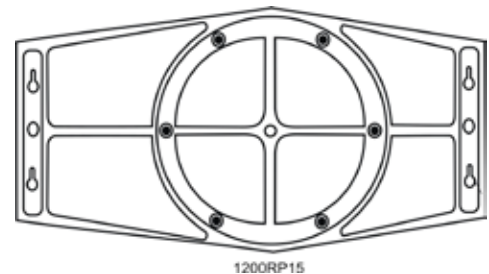

### 24" Ribbed Mounting Plate (1200RP)

For larger instruments, the ribbed structure of this plate provides the maximum support. Our machinist begins with thick aluminum plate and carves a strong rib structure. The final result is 1.5" thick, 24" long and 7.6" at its widest point. The width of the plate tapers to 5.5" at each end. A pair of keyhole slots that measure 3.2" between centers are provided at each end. The distance between these pairs of holes is 23". Due to the ribbed structure, you may not be able to drill additional holes for non-Astro-Physics mounting rings. The plate weighs an amazing 9.5 lb. for its size. This is a view of the rib structure on the underside of the 24" plate.

Attach this plate with six 1/4-20 x 1" socket head cap screws.

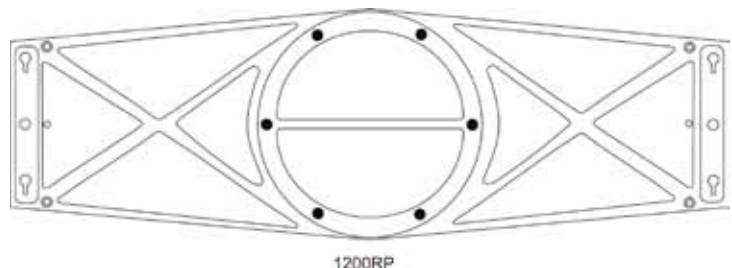



## Losmandy D-Style Compatible Saddle Plates

### 8.5" Dovetail Saddle Plate for Losmandy D-Style Plates (DOVELM2)

This Astro-Physics plate attaches to the 400, 600E, 900, 1200 and 1600 mounts. If you already own one of the Losmandy DAP series (fits Astro-Physics refractors), DC series (for Celestron 8" 9.25" or 11" SCTs) or DM series (for Meade 8" and 10" SCTs) plates, you should consider this plate or the longer ones below. For larger size SCTs we recommend the longer DOVELM162 – see below.

Note that the two bolt-hole patterns are offset from the center. This allows you to position the plate either forward or backward depending on the balance point of your telescope. Attach this plate with four 1/4-20 x 3/4" socket head cap screws and/or two 1/4-20 x 5/8" flat head socket cap screws.

Additional features include a center position knob-hole for use with short D-style plates, a ribbed structure underneath to reduce weight and tapped 10-32 holes in the side for cable attachment.

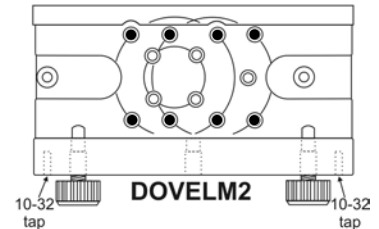

### 16" Dovetail Saddle Plate for 1200 and 1600 Mounts and Losmandy D-Style Plates (DOVELM16)

This Astro-Physics plate is no longer produced and has been replaced by the DOVELM162 below. If you already own one of these plates, and use a 17.25" or longer Losmandy DAP series (fits 6" and larger Astro-Physics refractors) plate, this mounting plate will work fine. SCTs, RCs and other instruments that are challenging to balance should use the DOVELM162 as shown below.

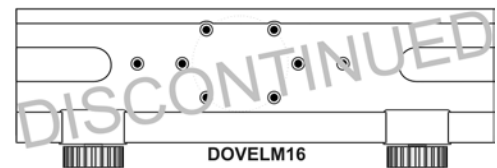

### 16" Easy-Balance Dovetail Saddle Plate for Mach1GTO, 900, 1200 and 1600 Mounts and Losmandy D-Style Plates (DOVELM162)

This Astro-Physics plate was introduced in February, 2009, and in mid-2010 we added the center clamp for even greater versatility. The DOVELM162 provides a multitude of mount attachment options, and was specifically designed to meet the balancing demands of "back-end-heavy" instruments like SCTs and Ritchey-Chrétien, especially those with heavy imaging gear hanging off the back!

This plate has small knobs to avoid interference with the declination hub, but the knobs have cap screws in the ends that accept a 3/16 hex wrench for extremely secure clamping of your instrument. Additional features include ribbed structure underneath to reduce weight and tapped 10-32 holes in the side for cable attachment. This is the perfect saddle for our SBD16 16" Versatile Dovetail Plate!

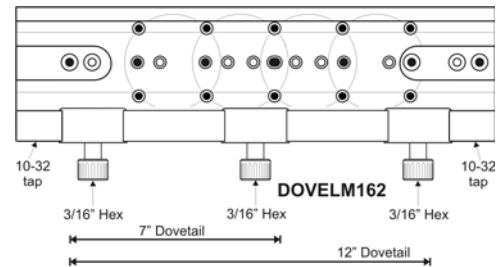

Note that the bolt-hole patterns are marked with scribe cuts. The four-hole patterns can all be supplemented with bolts along the optical axis in the six-hole pattern giving six attachment points at each position. Attach this plate with four 1/4-20 x 1" socket head cap screws and possibly one or two 1/4-20 x 3/4" flat head socket cap screws.

## Astro-Physics Dovetail Option

### 15" Astro-Physics Dovetail Saddle Plate (DOVE15) for 15" Sliding Bar (SB1500)

The 15" version of our dovetail plate is suited for the 130 f/8 StarFire EDT, 155 f/7 StarFire EDFs, ARO Maksutovs, Takahashi scopes and other instruments of similar size. The knob assembly features a brass pin with a tapered end to hold your sliding bar firmly without marring the aluminum. Use with the 15" Sliding Bar (SB1500), which is sold separately (**NOT** for use with Losmandy "D" or "V" plates or Vixen plates). Also makes a great accessory plate when used with any configuration employing the standard AP 13.75" ring spacing, including the SBD16, 1200RP15 or FP1800 (with rings mounted to inside holes).

Attach with four 1/4-20 x 5/8 flat head socket cap screws.

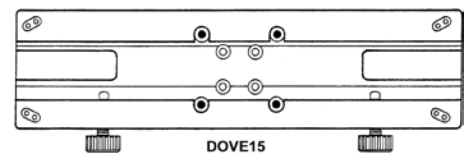

## Side-by-Side Configurations with D-Style Saddles

A variety of Losmandy D-style side-by-side configurations are possible using either the 13" or 16" Side-by-Side Plates (SBD13SS, SBD16SS). One example is shown in the photo to the right where a 16" D-style Dovetail Saddle (DOVELM162) is attached on the right and an 8.5" Losmandy D-style Dovetail Saddle (DOVELM2) is attached on the left. It is also possible to set up a side-by-side configuration using combinations of these saddles attached to the Side-by-Side plates. When assembling a multi-scope system you have to be mindful of the total combined weight of the components and accessories (remember that a simpler system is always better)..



## Astro-Physics P-Style Compatible Saddle Plates

### 16.5" Dovetail Saddle Plate for PlaneWave Dovetail Plates (DOVEPW)



This robust plate allows attachment of instruments like the PlaneWave CDK17 or CDK20 that use their 7.652" wide dovetail plate. The plate was originally designed for the 3600GTO mount, but it works extremely well on the 1600GTO with the PlaneWave CDK17 and CDK20. We do not recommend their larger scopes for the 1600GTO. Four clamps secure the instrument like a vise! Note that the attachment screw placement requires that the plate be rotated 90 degrees from the conventional orientation in order to accommodate the two center clamps. You can achieve an added measure of security when using our 23" P-Style Dovetail Plate (SBPW23). A series of matching 1/4-20 holes in each plate enable you to bolt them together once the balance position of your instruments is achieved. Attach with six 1/4-20 x 1" socket head cap screws.

## Side-by-Side Configurations with P-Style Saddles

A variety of P-style side-by-side configurations are possible using the 23" Dovetail Plate (SBPW23). One example is shown in the photo to the right where a P-style Dovetail Saddle (DOVEPW) is attached on the right and a 16" Losmandy D-style Dovetail Saddle (DOVELM162) is attached on the left. It is also possible to set up a side-by-side configuration using two, or even three, DOVELM162 saddles attached to the SBPW23. When assembling a multi-scope system you have to be mindful of the total combined weight of the components and accessories (remember that a simpler system is always better). An additional DOVEPW will be used to attach the SBPW23 to the mount.



# ATTACH COUNTERWEIGHT SHAFT AND COUNTERWEIGHTS

## IMPORTANT:

- Always attach the counterweights before mounting the telescope to the saddle plate to prevent sudden movement of an unbalanced tube assembly, which may cause damage or injury.
  - Remember counterweights are heavy and will hurt if they fall on your foot.
1. Thread the Counterweight Shaft onto the Dec. axis. Be careful not to cross-thread! Do not tighten too much, since you will need to remove it. Also be sure that the Delrin washer is in place on the threads to facilitate the shaft's removal later.
  2. Remove the machined Safety Stop from the end of the Counterweight Shaft. Add sufficient counterweights (5, 10, 18, 24 or 30 lb. counterweights are available) to the shaft to balance the telescope you intend to use. Loosen the counterweight knob and hold the counterweight with the knob pointing downward so that the brass pin will move from the center opening allowing the counterweight to slide into position. Always use two hands to attach or move them on the shaft. It is advisable to have the counterweight knob pointing down toward the pier. This will minimize the chance of accidentally loosening the counterweight during the observing session.
  3. Re-attach the Safety Stop to the end of the Counterweight Shaft. This will help to prevent injury if someone accidentally loosens the counterweight knob.

NOTE: A firm tightening of the counterweight knob will not damage the surface of the Counterweight Shaft. The pin that tightens against the stainless Counterweight Shaft is constructed of brass.

# ATTACH MOUNTING RINGS AND SCOPE

*(purchased separately)*

**If this is your first session with your new mount, you may wish to read the “Understanding R.A. and Dec. Clutch Knobs” section before attaching your telescope. This will give you an idea of how the clutch knobs feel and function.**

**Flat and ribbed plates:** Our flat and ribbed plates are constructed with keyhole slots at the location where your mounting rings attach. This feature enables you to partially loosen the screws on your rings just enough to insert them into the larger part of the keyhole, then slide the rings to the narrow part and tighten them with a hex key. We prefer this keyhole method to the standard way of completely removing the screws and dropping them in the grass.

We suggest that you install the rings on the mounting plate, then open the rings, lift the scope in place, close the rings and tightened the knobs. To balance the scope, you can loosen the knobs enough to slide the scope forward or backward as needed.

Another approach is to attach the rings to the scope beforehand, then lift onto the mounting plate. However, the rings must be spaced exactly the correct distance apart to match the holes in the plate. This maneuver may be particularly difficult to accomplish with a large, heavy instrument.

**Dovetail plates or sliding bars:** Attach mounting rings to the male dovetail plate (sliding bar) matching the appropriate threaded holes on the bottom of the mounting ring. Again, you have the option of attaching this dovetail / ring assembly to the mount and then lifting your scope in or placing the scope in the rings, then lifting the entire assembly to the female mounting plate already attached to the mount. Dovetail plate / sliding bar combinations are quick, versatile and convenient – hence their popularity. Simply loosen the knobs and “tilt” the sliding bar into place in the dovetail receiver. Once in place, tighten the knobs to lock everything securely. Loosen the knobs and slide the scope / rings / sliding bar assembly in the dovetail channel as needed to balance the system, and then re-tighten when balanced.

# UNDERSTANDING THE R.A. AND DEC. CLUTCH KNOBS

We suggest that you read this before assembling the remainder of your system.

1. What do they do?

The three R.A. and three Dec. Clutch Knobs depicted in the Assembly Diagram have the function of connecting the R.A. and Dec. Axes to their respective drive worm wheel gears. Their function is progressive, from slight tension (axes free to move - as required during correct balancing of the telescope) to a completely "locked up" state.

2. How can you find out what they really do?

As shipped, all 1600 mounts have both sets of R.A. and Dec. Clutch Knobs firmly hand tightened. This will give you a good idea of the maximum tightness (clutch action) that can be achieved by hand effort alone. At this point, you must bear in mind that for optimum performance all three clutch knobs on each axis (R.A. or Dec.) should be tightened evenly to the same tension i.e. all three half tight, all three fully tight, etc.

In order to feel the effect of the clutch knobs, you may wish to partially assemble your mount. Fit together the R.A. and Dec. Assemblies plus mounting plate and counterweight shaft. Do not put scope and counterweights on at this stage. With the above assembly (with the clutch knobs firmly hand tightened - "as shipped"), you can feel the amount of force needed to move each axis by hand. Grab each end of the telescope mounting plate and move it with a backward and forward movement of the Dec. Axis. You will feel considerable resistance to this motion. Perform the same operation on the R.A. Axis by moving the counterweight shaft backward and forward. With a well-balanced telescope, the above tightness of the clutch knobs will be sufficient for all normal conditions of use.

Now, if you proceed to mount up and balance your telescope, you can "feel" what this resistance in R.A. and Dec. (movement backwards and forwards) is like when you make these motions from the eyepiece end of your telescope as you would during normal use when slewing (pushing) by hand to acquire an astronomical object within the field of view of your finder or scope.

3. How tight can the clutch be and can you do any damage by pushing against them?

The clutches can not be damaged by tightening; however, it is not necessary to tighten them as you would tighten the lug nuts of your car's wheel. You will see that each clutch knob has a 5/32 hex socket for tightening with a hex key. With an extra 1/3 turn beyond hand tightening on each clutch knob, the axis (axes) will be considered completely "locked up" and you should not attempt to push your scope by hand against this "locked up" resistance, or undue stress will be placed on the worm wheel / worm and bearings.

Naturally, if you have a very heavy load, it is advisable to tighten the clutch knobs more than is necessary when a lighter payload is mounted. When imaging you'll want to ensure that the clutches are tighter so that there is no slippage. Some recommendations follow.

4. How do the Clutch Knobs of the 1600GTO differ from all 900 and 1200 mounts?

The 900 and 1200 mounts were designed with Delrin clutch plugs beneath the knobs. While these were quite effective as a clutch material and did not damage the underlying worm wheel surface, over time the base of the clutch plugs spread out after being tightened with greater force than necessary, preventing their full release.

The 1600GTO uses a different clutch system, and it also uses a different bearing system for the free rotation of the axes. It will feel stiffer than the 900 or 1200 series mounts.

You should be aware that the clutch knobs on the 1600GTO have spring loaded tips that may still be applying pressure to the clutches, even though the clutch knobs feel loose. Back the clutch knobs off by at least two or three full turns to more fully disengage the clutches. There will always be some friction. The 1600GTO clutches can be fully tightened without worry.



**WARNING! Be careful when moving the mount with the clutches. It is possible to catch cables or fingers between the clutch knobs and the motor/gearboxes if you are not careful!**

# BALANCING THE TELESCOPE

To achieve the best performance from your mount, your telescope should be well-balanced. This is more important for imaging setups than for visual setups since greater precision is required for guiding. Those who are setting up for visual use or casual imaging need only be “adequately” balanced, as the mount’s drive system is very robust.

Common sense dictates that you want to begin the balancing procedure with your setup counterweight heavy so that the scope does not suddenly leap from your hands and spin around into the pier. As long as the counterweight is down, sudden movements of the Dec. axis cannot cause a damaging mishap. You will want to perform the balancing with the scope set up exactly as it will be used. Eyepieces, diagonals, finder scopes, cameras, guiders, etc. should all be in place before you begin.

## Preliminary Balancing

1. With the counterweight shaft down and the scope pointing east (Park 2), loosen the Dec. clutch knobs (about 3 to 4 full turns) and feel which way the scope’s weight is offset. Placing a hand on each end of the scope and lifting back and forth will give you a good feel for balance. Slide the scope (in its rings or via the dovetail) until it feels balanced, then point the scope to the north again and tighten the clutches.
2. Next, loosen the R.A. clutch knobs (about 2 to 3 full turns) and, while holding the counterweight shaft, move the axis into a horizontal orientation. You will probably need to rotate the Dec. axis a bit so that it also assumes a horizontal orientation. Place a hand at the end of the shaft and on the scope and, lifting back and forth, make counterweight adjustments to equalize the balance as best possible.

This degree of balancing will be sufficient for those who wish to have some fun doing visual observing with family and friends. If you are planning to do long-exposure, deep-sky imaging, then you’ll want to refine the balance. The steps below will walk you through precision balancing.

## Precision Balancing

Remember that dangling cables will dramatically change balance and create guiding problems, so you’ll want to be sure that all cables are carefully secured and not dragging before you proceed with balancing. Ensure that your focuser is in its focused position, the dew shield extended and the dust cap removed. The following three recommendations will increase guiding performance.

1. *Slightly* offset balance to the counterweight side of the R.A. axis. When the axis is perfectly balanced horizontally, then offset the weight just enough to start motion *slightly* downward on the counterweight side.
2. *Slightly* offset balance to the camera side of the Dec. axis. When the axis is perfectly balanced horizontally, then offset the scope just enough to start motion *slightly* downward on the camera end.
3. The counterweights should ride high on the counterweight shaft. It is best to add counterweights and slide them to the top of the shaft with the heaviest at the top and then use the smallest weight to perform the precision balancing. The reason for this is called “Inertial Moment Arm”. Sliding less weight down the shaft will balance the scope, but will greatly increase the moment arm force; that is to say, it will require a much greater torque to start the axis rotating. (Think of a tightrope walker using a long rod to stabilize his balance.) This is a very important consideration when you are trying to do precise guiding. See illustration at right.

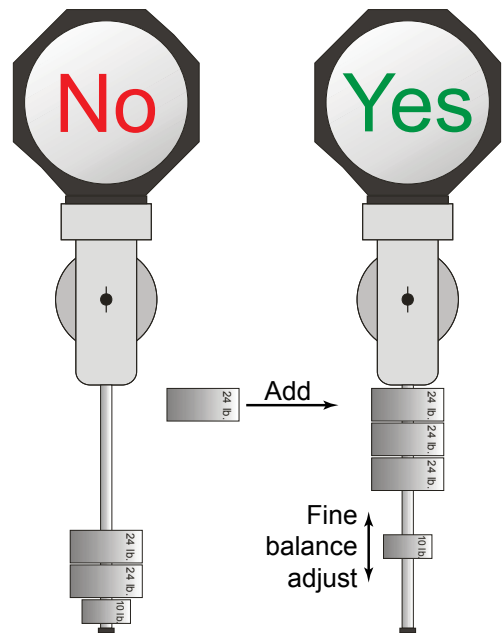

## Disengaging the Worm and Worm Wheel

The new motor / gearbox design allows complete disengagement of the worm from the worm wheel allowing the axis to turn freely for careful balancing. It is important to begin with the scope approximately balanced since it will be free to abruptly spin when the gears are disengaged. You definitely do not want the scope to yank from your hands and crash into the pier!

On the following page is a pictorial sequence that shows how to disengage the gears. It is as easy as flipping a lever!





1. Grip the Lever Assembly Cover and pull it free to expose the Lever inside. There are grooves on either side of the cover to assist with your grip.
2. Rotate the Lever 180° to disengage the worm (never force it past its limits). When you rotate the lever, the motor gear-box will tilt and disengage the worm from the worm wheel. **Caution: The axis will spin freely when disengaged.**
3. Rotate the Lever back when balance is complete. Once balance has been completed, *gently* turn the lever and re-engage the worm and worm wheel (shift the axis as needed). Rotate it fully into place and replace the cover.

### OK...Let's balance!

1. Be sure that a preliminary coarse balance has been done so that no unexpected swings of the scope take place. Be sure that the clutches are tight on both axes. You will not use the clutches to balance the mount.
2. **R.A. Axis** -- Release the gear mesh in the R.A. axis as described in the pictorial above. While holding onto the counterweight shaft, swing the shaft to a horizontal position either east or west to your convenience.
3. Slide the heavier weights to the top of the shaft and try balancing with just the lower, lighter weight. If you must, slide the weights lower as necessary to balance, however, it is better to add another heavy weight up high.
4. Once you have the balance perfect with the axis horizontal and not moving, then slide the lowest weight slightly further down the shaft so that the axis has a small amount of drift in that direction. You want a little bit of offset...not much.
5. Position the axis horizontally and then gently turn the lever to re-engage the worm and worm wheel. You may need to slightly rotate the axis so that the gears drop into mesh.
6. Once the lever is fully in its locked position, replace the cover and move on to the Dec. axis.
7. **Dec. Axis** -- Release the gear mesh in the Dec. axis as described in the pictorial above. While holding one end of the scope, swing the scope into a horizontal position.
8. Loosen the tube mounting rings or the dovetail saddle locking knobs and position the scope so that it is perfectly balanced and stable in a horizontal position. Remember that the camera should be in its focused position for accuracy.
9. Once you have the balance perfect with the axis horizontal and not moving, then slide the scope slightly toward the camera end so that the axis has a small amount of drift in that direction. You want a little bit of offset...not much.
10. Position the axis horizontally and then gently turn the lever to re-engage the worm and worm wheel. You may need to slightly rotate the axis so that the gears drop into mesh.
11. Once the lever is fully in its locked position, replace the cover and you are finished. Now you can loosen the clutches and reposition the scope into a reference Park position so that you can power up and be oriented.

# ALTITUDE AND AZIMUTH ADJUSTMENTS – ROUGH POLAR ALIGNMENT

It is recommended that you not attach the RAPAS until you have roughly centered Polaris through the site hole.

For rough polar alignment, your goal is to sight the celestial pole when looking through the polar alignment sight hole. You will need to make altitude (up/down) and azimuth (side-to-side) adjustments to the position of the mount.

*[An inclinometer and a compass adjusted for magnetic declination at your location (or these functions on a smart phone App) can be very helpful for daytime setup. In addition, be sure to learn the Daytime Polar Alignment Routine as described in the keypad manual. It is a great method for rough alignment!]*

**Note on Bubble Levels:** It is possible to achieve perfect polar alignment without having the pier level, but it is slightly more difficult. With a pier that is not level, each adjustment in azimuth also causes a minor shift in altitude and vice versa. This is why we have included the bubble level on the 1600GTO. However, don't waste time obsessing about having the pier perfectly level. This is, after all, NOT an Alt/Az mount! Devote the time to the actual polar alignment instead. If you are reasonably close to level, you will not be able to notice a difference. Keep in mind that unless you are a serious astrophotographer or imager, "perfect" polar alignment is not critical.

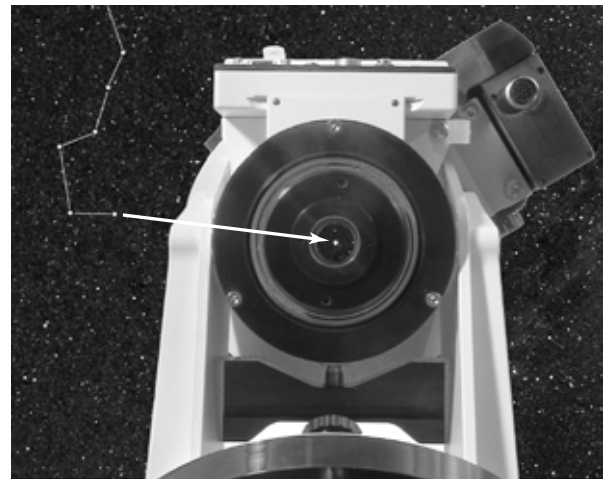

Sighting Polaris through  
Polar Alignment Sight Hole (900GTO shown)

1. Remove the Dec. axis sight hole cover, to complete these steps. Examine the polar axis assembly and you will see that the center of the R.A. shaft is hollow.
2. **Azimuth adjustments:** To begin, move or turn the entire pier or tripod east or west until the mount is oriented approximately towards the pole (an imaginary line drawn through the hollow shaft). Next, use the two fine azimuth adjustment knobs, one on each side of the mount, to make adjustments. You must back off the opposing azimuth knob in order to move the other knob in that direction.

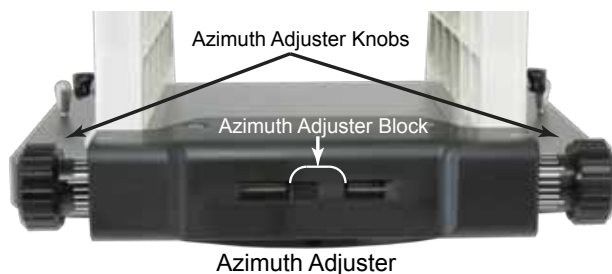

**One full turn of the azimuth knob is approximately 0.3733 degrees (22.4 arcminutes). Small graduations are 0.74 arcminutes; long graduations are 3.7 arcminutes.**

The best adjustment technique to use with the Astro-Physics Azimuth Adjuster, with its clear registration marks for fine adjustment, is to back off one of the knobs by a set amount (a certain number of registration marks) and then to turn the other knob until you re-establish contact on both sides of the Azimuth Adjuster Block. You can very precisely zero in on the desired position with no backlash or ambiguity on the position. You can also always go back to the precise starting point if for some reason you overshot your mark (or if you adjusted the wrong way), because you know exactly how far you've gone. This is explained further in the section on Fine Polar Alignment.

3. **Altitude (latitude) adjustments:** Loosen the Altitude Lock Knobs. Move the polar axis up or down with the large Altitude Adjustment Knob located in the front of the polar axis assembly. We have found that using the turnbuckle on the north leg of our pier also can make fine altitude adjustments, if used.

**One turn of the altitude knob is approximately 0.41 degrees (24.6 arcminutes).**

4. Continue your azimuth and altitude adjustments until you center Polaris in the polar alignment sight hole. At this point, you have achieved a rough polar alignment, which may be sufficient for casual visual observations, if you are not planning to slew to target objects with the keypad. When the R.A. motor is engaged (the power is plugged in), it will compensate for the rotation of the earth and keep the target object within the eyepiece field of view. If your target object slowly drifts, you can make corrections with the N-S-E-W buttons of your keypad controller.
5. Tighten the Altitude Lock Knobs by hand.

# POLAR ALIGNMENT OPTIONS – FINE POLAR ALIGNMENT

For casual visual observation, you may skip this section and simply start observing. A finder-scope or single power finder may be required to locate objects since GoTo slews with the keypad require good polar alignment for spot-on accuracy. Don't forget to tighten your Altitude Lock Knobs (4) before you begin! For casual visual observation, you can move the telescope manually via the clutches or by using the GoTo and centering functions of the keypad.

The keypad and GTO Servo Control Box will function as soon as they are plugged in. That means that the R.A. axis will be moving westward at the sidereal rate. Note, however, that this motion will not be accurate enough to qualify as "tracking" without accurate polar alignment. In short, if you will depend on the GoTo functions of the 1600GTO, or if you intend to do astrophotography, you must perform a more accurate polar alignment. Some methods, procedures and tips are presented below. You will complete this alignment when your scope and other equipment are mounted.

## Methods for fine polar alignment

- **Polar Alignment Scope** – Our optional Right-Angle Polar Alignment Scope (RAPAS) will allow you to quickly align your mount on the pole. The reticles are designed for use in both the Northern and Southern hemispheres. Even users of the GTO computerized mounts will find these polar scopes useful, particularly if your telescope is not orthogonal to the mount (please refer to the keypad manual for a discussion of orthogonality). If you have a polar alignment scope, please read the instructions sheets that come with it. If you are planning long-exposure astro-imaging, we suggest that you use the polar alignment scope, then tweak the final polar alignment by using traditional drift alignment, the GTO Quick Star-Drift Method (refer to the Keypad v4.19.2 manual), *PEMPro™* Pole Align Wizard or other similar alignment program.
- **GTO Keypad** – Please refer to the instruction manual for the GTO Keypad and read the sections from "Getting Started" through "Alternate Polar Calibration Routines & Tips." As time goes on, the keypad manuals will be updated. Please refer to the Technical Support section of the website for the most recent documentation. Here are summary descriptions of several techniques for polar alignment from the current Keypad Manual available on the Technical Support page of our website.
  - The Keypad startup routine provides two methods: The North Polar Calibrate and the Two Star Calibrate. These two polar alignment methods, though no longer recommended, were designed for quick and coarse alignment in the field with portable setups. They are for visual observers, not imagers. The Two Star Method is the better of the two as it is less affected by the extremely low resolution in R.A. near the pole and by orthogonality issues.
  - The Daytime Routine (see "Polar Aligning in the Daytime" in the Keypad Manual), is a great trick for daytime setup. It will allow you to "wow" your friends by setting up and finding planets and bright stars in the daytime. In addition, it is the recommended first step in alignment for anyone in the southern hemisphere. Even those in the south who own our polar scope will find it helpful, since it will generally put the rather difficult-to-spot southern stars into the polar scope's field of view.
  - The GTO Quick Star Drift Method is for use with a finder scope. By using a finder scope, you are able to remove orthogonality issues from the process, making subsequent alignments much easier.
- **Computer Software Solutions** –
  - Polar Align via *PEMPro's* "Pole Align Wizard" – *PEMPro™* is a software by Ray Gralak and distributed by CCDWare. This powerful application not only analyzes and improves the periodic error performance of any mount that is equipped with a CCD camera and compatible camera control software, but also includes "Pole Align Wizard".

"Pole Align Wizard" is THE best method of accurately polar aligning! It is like traditional drift aligning, but on steroids! It has the advantage of automatically choosing the optimized stars for drift aligning and does not have to worry about star magnitude since the CCD can see dimmer than an eye. Also, it compensates for air refraction and other variables that manual drift aligning cannot. It does require the use of a CCD camera and corresponding camera control software. The Wizard walks you through the alignment process with easy step-by-step instructions. **Note: This is the preferred alignment method when tweaking the RAPAS orthogonality.**

A full *PEMPro™* edition is included with the 1100GTO, 1600GTO and 3600GTO mounts (sorry, not the *Mach1GTO*).

- Other Software – There are many software packages that include aids to polar alignment that can be found through a Google search. Some will work better than others. Do not be fooled into thinking that your alignment is perfect simply because a piece of software told you so. Polar Alignment is, after all, entirely a mechanical issue. Apart from “Pole Align Wizard”, we do not have experience with these other software programs and cannot vouch for them or provide support.
- **Star Drift method** – Traditionally, this very time-consuming procedure has been regarded as the most accurate method of polar alignment. However, if you are using the old method of drift alignment that employs stars near the eastern or western horizon, you may encounter problems from atmospheric refraction, which will skew your alignment. To obtain more accurate results, choose stars somewhere near the celestial equator due south or slightly east and west, but not below 45 degrees elevation.  
 For portable setups, we believe that our GTO Quick Star Drift Method using the Meridian Delay Feature and a Finderscope (found in the keypad documentation as noted above) is a much more practical approach in terms of providing highly accurate alignment and still leaving enough time to actually get some imaging done. A permanent observatory setup where long unguided exposures are taken may still benefit from a final tweaking using the traditional star drift method (as modified by the 45 degree elevation recommendation above) or from a software enhanced variant like the *PEMPro™* Pole Align Wizard that allows a CCD to measure and calculate the drift much faster than can be done at the eyepiece.
- **Helpful Advice** – Members of the ap-gto Yahoo group occasionally discuss alternative methods of polar alignment that they have found helpful. We suggest that you participate in this Internet discussion group. Follow the links from the sidebar of our website to find the group.

## ***Making Precise Altitude and Azimuth Adjustments***

The mechanics of altitude and azimuth adjustment are relatively straightforward. In the discussion below, we will provide some information and tips that will give you the greatest success with your 1600GTO regardless of the polar alignment method you choose for determining the amount and direction of each adjustment. We'll leave the choice of method up to you. (Did we mention the GTO Quick Star-Drift Method?) We list the fine altitude adjustment first because our GTO Quick Star-Drift Method begins with altitude. Many texts for the classic star-drift method begin with the azimuth adjustments.

When you made your rough alignment earlier, you loosened everything up, got the mount close, and then tightened everything back down. Any minor shifting that occurred from locking things down tight was of no consequence since it was a rough procedure. Now you are fine-tuning the alignment. Regardless of whether you start with altitude or azimuth, begin the fine adjustment process with **everything** locked down as if you were already finished. Then, loosen only what is required to make the adjustment, and loosen as little as possible. Your final adjustment should always be with everything virtually, but not quite fully locked. It is may be helpful to use the technique of tightening the knobs a little more with each new adjustment.

### **Fine Altitude Adjustment**

Slightly loosen the four Altitude Lock Knobs, but do NOT loosen the polar axis pivot screws. Move the polar axis up or down with the large Altitude Adjuster Knob located in the front of the polar axis assembly. If lowering the axis, you may need to “help” the axis down if your lock knobs are somewhat tight. If you lower the axis, always be sure that the axis remains in firm contact with the stainless steel thrust pad. Please refer to the illustrations earlier in this manual if you are unsure about these parts. It is also possible to make fine altitude adjustments by using the turnbuckle on the north leg of our pier, if used. **Final adjustment should always be made pushing up in altitude.**

**One full turn of the altitude knob is approximately 0.41 degrees (24.6 arcminutes).**

### **Tips for Adjusting the Altitude**

1. The mount's polar axis is held in place between the two side plates. It is possible for the mount to shift slightly when the locking knobs are fully tightened down after adjustment of the altitude angle. To prevent this shift, it is suggested that the initial fine altitude adjustment be done with these knobs hand snugged, and as you approach the final adjustment point, tighten the knobs, first to hand tight, and finally with a hex key after each small movement. As you converge on the pole in altitude, each successively smaller adjustment is made against greater resistance from the ever tighter lock knobs.
2. Approach the pole from below and try not to overshoot. If you accidentally move the axis too high and overshoot the altitude angle, it is better to loosen the two lock knobs a bit, and bring the axis back down a very small amount before proceeding back up with the knobs tightened up again. This way you are using the weight of the mount to insure a solid connection to the altitude adjuster. The “captain's wheel” design of the Altitude Adjuster Knob provides the necessary leverage during the final “tweaking” adjustment phase when the locking knobs are quite tight.

## Fine Azimuth Adjustment

The one-piece Azimuth Adjustment assembly makes for easy and accurate polar alignment in your observatory or in the field, and it eliminates issues of adjustment backlash. The heavy-duty construction and integrated one-piece design result in smooth control of the azimuth axis. Large left and right adjuster knobs are graduated for precise control of azimuth position angle.

**The small graduations are 0.74 arcminutes per graduation; long graduations are 3.7 arcminutes per graduation; one full turn is 0.3733 degrees or 22.4 arcminutes.**

The size of the knobs makes them easy to turn with very little torque required, even with the mount fully loaded. Take full advantage of the graduation marks on the Azimuth Adjuster when performing fine alignment to mark your starting and ending points for each adjustment. This will allow you to exactly undo any adjustments that are made in the wrong direction. Do not leave the knob you have backed off loose. When finished, both knobs must be tight against the azimuth adjuster block to hold the azimuth angle you have set. If you follow our hint below, the act of adjustment will leave the adjusters tight against the azimuth adjuster block!

**Important Hint:** The natural tendency when making azimuth adjustments is to first back one adjuster knob off a significant amount, then make the required azimuth adjustments with the other knob, and then when finished, to tighten the first knob back up against the azimuth block. This can result in a slight shift as the first knob is tightened against the block. We recommend that you completely abandon this approach for fine azimuth adjustment.

Instead, we recommend that you start with both knobs tightened against the azimuth adjuster block. Then, ***back off the first knob only by the small amount of the adjustment you plan to make.*** Use the graduated markings on the knob to mark your starting and ending points. For example, if you are already pretty close, you might try backing off just two small graduations, or roughly 2 arcminutes. Finally, make the actual adjustment by tightening the other knob thereby making the tiny adjustment you required and eliminating any shift because everything is already tight when you are finished. By using the graduations, you can easily undo any errors or estimate the magnitude of your next adjustment.

## Precision-Adjust Rotating Pier Base with Azimuth Bearing

Under normal circumstances, the Precision-Adjust Rotating Pier Base does not require adjustment. However, you may, on rare occasions, need to adjust these screws to gain the proper feel during the adjustment process.

The Precision-Adjust Rotating Pier Base consists of two plates that allow ultra-smooth adjustments for critical polar alignment. Notice the two Delrin screws on the underside of the Precision-Adjust Rotating Pier Base. They are located at the "NW and NE" positions. These screws are used to apply tension to the rotating plate. If you notice a slight amount of shift, particularly with a larger scope, carefully tighten the screws a small amount. **DO NOT overtighten!** If you find too much resistance, then loosen the screws slightly.



## Using Software to Improve Pointing Accuracy

Software solutions are available today that will help to compensate for orthogonal problems as well as other idiosyncrasies of your telescope, mount and optics. These programs analyze and compensate for these problems, resulting in improved telescope pointing performance.

- Astro-Physics Command Center (APCC), Pro version with pointing and tracking model, [www.astro-physics.com](http://www.astro-physics.com)
- *MaxPoint*™ Modeling Software from Diffraction Limited, [www.cyanogen.com](http://www.cyanogen.com)
- *TPoint*™ Modeling Software from Software Bisque, [www.bisque.com](http://www.bisque.com)



## MISCELLANEOUS ITEMS

### ***Bubble Level and Lanyard Post***

We have added a Lanyard Post on each side of the 1600GTO mount. Its purpose is to provide a convenient place to hang the Keypad lanyard during an observing session. Additionally, there is a Bubble Level for your convenience. See *Photo at right*.



### ***Warning for Dec. Servo Cable***

One of the most important things to remember when disassembling the 1600GTO for transport is to disconnect the Dec. Servo Cable before separating the two axes. We all need a reminder from time to time and so we have posted a decal on the Dec. axis reminding you not to forget to disconnect it. See *Photo at left*.

## SLEWING YOUR MOUNT IN BELOW FREEZING TEMPERATURES

There are several potential problems when slewing your mount in below freezing temperatures. The symptoms are a wavering or chattering sound from the motors, a slowing down of the slewing with a sudden jolting stop at the end of the slew, and in the worst case, a continuous running of the motors and loss of control. The following are three suggestions to alleviate the problem:

- First, in cold weather it takes significantly more power to slew the motors than it does in the summer. This extra current drain can cause a voltage drop in the power cord running from the supply to the GTOCPx control box. It is therefore especially important that you not use extension cords between the mount's cord and the DC power source. If you must have a long distance between the supply and GTOCPx control box (unavoidable in some observatory situations), use a heavy wire to minimize the voltage drop.  
  
If the power drops below about 10.5 - 11 volts at the servo terminal, the internal computer chips may reset with subsequent loss of control of the motors. If your supply is marginal, it may also not produce the voltage necessary for proper operation during slews. It is a good idea to limit the slew speed to 600x during real cold weather to reduce the power demand from the supply.
- Second, it is very important not to have the worm mesh set overly tight. One symptom of an overly tight worm is a chattering sound as the motors try to slew at 1200x or even as low as 600x. You can check to see if the worm turns easily by removing the motor covers and then rotating the large aluminum spur gear. Try turning it by hand one full turn in each direction. If it does not easily turn, then the motor will also have a difficult time turning it. Check in our technical section of the AP web site to learn how to set the worm mesh.
- Third, under extreme cold temperature conditions (below -20F) it may be necessary to replace the grease on the worm wheel teeth with a lighter material. We are currently using a grease called AeroShell 33 which has a very wide temperature range and promises to be effective even during these cold temperatures. We have tried straight low temperature greases that work to -80F, but in each case the worm gears get abraded very quickly. Using no grease at all is also not recommended for a GoTo system that slews at high speeds. The wear on the worm and wheel teeth is extremely high and can lead to high periodic error due to scratches and high spots that develop on the gear teeth.
- Fourth, we recommend using a 15 volt power supply for heavier loads. We have found that the higher voltage improves motor performance when operating under these adverse conditions. Do not exceed 16 volts.

# GEAR MESH IN THE 1600GTO

The good news is that the 1600GTO is always in mesh, thanks to the Auto-Adjusting Motor Gearboxes!

The 1600GTO mount represents a new era in the ease of gearbox adjustment. Our new design eliminates the need for gear mesh adjusting. It has become automatic. The only adjustment that may ever need to be made is to set a backstop... and that is rarely needed.

## Checking and Adjusting the Gearboxes in R.A. and Dec.

Thanks to the simplicity of the gearbox adjustment procedure this is a very simple and quick process.

### To check for a loose gear mesh:

1. Put the mount into a Park 3 position (counterweight shaft down and scope in-line with the R.A. axis). This will ensure that any out of balance load will not affect precise meshing.
2. Power should be turned off.
3. In the R.A. axis, take hold of the end of the Counterweight Shaft with your fingertips and attempt to rotate the axis back and forth. Similarly, the Dec. axis is checked for looseness by taking hold of the telescope or saddle plate and attempting to rotate that axis back and forth. Do you feel a slight "thudding" looseness or is it solid? Gripping with your fingers, rather than with your hand, will give more sensitivity. If a problem is not found, then you are finished.

### If a problem is found, do the following:

(Tool needed: 5/64" hex key)

1. Put the mount into a Park 3 position. This is important to ensure that there is not uneven pressure on the gears due to an out of balance load when gear meshing. Be sure that the mount is powered off. Park 3 is counterweight shaft down and scope in line with the R.A. axis, pointing toward the pole.
2. Remove the Lever Assembly Cover. Grip the cover and pull it straight out.
3. Loosen the Lever Assembly screws. Using a 5/64" or 7/64" hex key, loosen the two screws (#1 in the illustration) so that the assembly is freed to move. This should require less than one turn of each screw.
4. Apply a slight pressure to the Lever Assembly. Using your index finger and thumb, apply a very gentle pinching pressure to shift the lever assembly towards your thumb (it only needs to touch). This sets the proper backstop position. Take great care not to push on the gearbox itself, as that would cause the box to pivot out of mesh and give a bad adjustment.
5. Tighten the screws. While maintaining the slight pressure, snug and then tighten both screws. Do Not Overtighten.
6. Replace the Lever Cover. Replace the cover and you are finished. It is that simple!

Repeat with the Dec. axis. Repeat the process with the Dec. axis, if necessary.

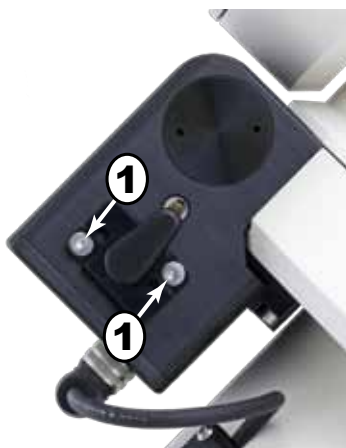

# MOUNT CARE, CLEANING AND MAINTENANCE

Like any fine piece of equipment, your mount's longevity and performance are directly correlated with the quality of the care that you give it. Handle it with respect, keep it as clean and dry as is practical, and perform a few minor maintenance tasks, and your 1600GTO will give you many years of trouble free service.

## Care

Although we build it to be rugged enough for field use, your 1600GTO is a precision instrument with very accurate worm and wheel adjustments. Please be careful if you place the mount on a flat surface, i.e. the ground or trunk of your car. The gear alignment may be affected if the R.A. and Dec. Motor / Gear Box assemblies sustain undue lateral force. This is true of any fine instrument. We suggest that you transport and store the mount in a case or in a well-padded box. ALWAYS disassemble the mount before moving it or transporting it. More damage can be done in a few careless seconds in transit than in many hours of normal operation.

Try to keep your mount protected from dust and moisture when not in use. In warm, humid weather, be aware of the dew that may have formed on the mount while in the field and allow the mount to dry out before packing it away for storage once you get home. On the other hand, if it is cold and dry outside, keep the mount packed up when you bring it into the house until it reaches room temperature to avoid "fogging it up." (The same advice applies to telescopes, eyepieces and other equipment in your Astro-arsenal.)

## Cleaning and Touch-up

Wipe your mount clean with a soft dry cloth. If needed, you can use a damp cloth or a cloth that has been sprayed with a mild, non-abrasive cleaner (window or all purpose cleaner – no bleach). Do not spray cleaners directly onto your mount. If you use a cleaning product, follow with a damp cloth to remove the chemicals from the mount.

The painted surfaces of your mount may end up with scuff marks from repeated transport and assembly / disassembly. Most of the time, these marks can be removed with a product like *Color Back™* by *Turtlewax™* (automotive product). Simply apply with a paper towel and buff out the mark. If your paint becomes chipped, touch-up kits are available for purchase – please call us.

NOTE: Paint touch-up kits can only be sold to U.S. customers due to regulations governing shipment of hazardous materials.

## Routine Mount Maintenance

Under normal operating conditions, minimal maintenance is required. If the R.A. and Dec. axes are attached together for a long time in outside conditions (i.e. in a permanent observatory) then the mating surfaces should be lightly oiled or greased – if you expect to get them apart again after 10 years.

Jostling and vibrations associated with transport to and from observing sites has had the effect of causing screws and fasteners to work their way loose over time. We have worked very hard in both the design and assembly of our mounts to alleviate this problem, but it is still a good idea to periodically (once or twice a year) inspect and if necessary re-tighten any easily accessible fasteners. Additional maintenance information can be found below in the troubleshooting section and in the Technical Support Section of our Web site.

# TROUBLESHOOTING, TIPS AND SUPPORT

## *Troubleshooting and Tips*

Additional troubleshooting questions are in the GTO Keypad or GTO Servo System manuals. Some of the issues discussed in these manuals relate to mount communication issues whether you use the keypad or control the mount with a planetarium program or *PulseGuide*™. Please refer to them.

### **The Declination (or R.A.) axis does not turn freely, even with the clutch knobs fully loosened.**

The design of the clutches is such that spring loaded tips always maintain some friction against the worm wheel. Consequently, the axes will never spin freely. Back the clutch knobs off by at least two or three full turns to more fully disengage the clutches. There will always be some friction. The 1600GTO clutches can be fully tightened without worry.

### **The LED on the GTO Control Box changes from red to yellow and the motors stop or go out completely (for control boxes shipped after 02-25-00).**

1. The voltage of your battery has probably gone below 10.5 volts.
2. The current rating of your AC-DC power supply is too low.

**Note:** The most common problems are due to inadequate power supply! Voltage must be measured while under load.

*Additional explanation:* During slewing under load, the two motors draw up to 3 amps from a 12-volt source. This may increase when the temperature approaches freezing or below. It is recommended that your supply be rated at a minimum of 12 volts DC at 5 amps continuous. 12.3 to 16 volts with a capacity of 5 to 10 amps is recommended for best performance. (Do NOT exceed a nominal 18 volt system.) See the Power Considerations section beginning on page 29)

If you also power other equipment (CCD cameras, dew heaters, etc.) from the same source (NOT recommended!), you will need a supply capable of up to 10 amps. The more equipment you have, the more current capability you will need. We always recommend giving the mount its own supply and using additional supplies for other equipment.

For portable applications, we recommend heavy-duty deep-cycle batteries designed for deep discharge applications (i.e. marine, golf cart, fork lift, or wheel chair batteries).

3. The motors are overloaded, probably due to an unbalanced load on your mount.

Rebalance your telescope, and then press one of the N-S-E-W buttons to reset the keypad. Re-enter the last object on your keypad and the scope will slew to the correct position. Even though your motors had stopped, the logic in the control box retained the scope position in memory. As long as you didn't change the pointing position of the scope, you are still calibrated.

If the scope was moved during re-balancing, simply enter a nearby bright star on the hand controller, press GOTO and allow the mount to finish slewing. You can then move the scope manually or with the N-S-E-W buttons to center the star in the eyepiece, and press the #9 RECAL button. This will recalibrate the mount.

*Additional explanation:* The GTO drive circuit includes logic for overload protection to prevent burning out the expensive servomotors in case of severe overload on the two axes. The primary cause is an unbalanced load in R.A. If the extra load opposes the motor rotation, the motor must work harder to track at the sidereal rate and the current will rise to high levels. If the current exceeds the trip point for more than a minute, the logic will shut the motor off and tracking stops. It typically takes about 4 lb. of unbalance to trip the overload, but a very heavy load of scopes, accessories and counterweights on the mount can decrease this unbalance threshold.

### **The keypad reset (or locked up) when I plugged my CCD camera, PC (or other equipment) into the same battery as the GTO mount was using. The battery has a meter, which shows 12V.**

The meter is reading an average and will not show dips. Gel cells have internal resistance, which will cause voltage drop when the load changes. When you connect an additional CCD camera and PC the load will drop below 9 volts and the keypad will reset or it may affect the GTO circuit itself and cause the keypad to lock up.

We recommend that you use a large marine battery that is not a gel cell and hook everything up to it before calibrating the GTO. Or, better yet, put the other equipment on a separate battery.

## **What is the maximum voltage that I can use to power the servo drive?**

Please refer to the Power Considerations section of the GTO Servo Motor Drive System manual.

**For polar alignment, I am using declination drift technique with stars on east & south. Now, I do not see any drifts in declination on both sites (E & S), so the mount “should” be properly aligned. However, I have still small drift in R.A. which looks like the R.A. motor is a bit faster than earth rotation. This drift is something like 1.5 arcseconds during 1 minute or so & accumulates over time, so it doesn’t look like periodic error.**

The sidereal tracking rate is exact in the mount (it is crystal controlled and checked here for accuracy). However, the stars do not move at exactly the sidereal rate everywhere in the sky. The only place they move at that rate is straight overhead. As soon as you depart from that point in the sky, the stars will be moving more slowly, especially as you approach the horizons. Thus, it looks like the mount is moving slightly faster than the sidereal rate. Just because you have done a classic drift alignment, does not mean that the stars will now be moving at the sidereal rate everywhere in the sky.

In order to increase the area of sky from the zenith that will give you fairly good tracking, you will need to offset the polar axis by a small amount. The amount will depend on what your latitude is. The other approach is to vary the tracking rate for different parts of the sky. Ray Gralak’s Pulse Guide will allow you to dial in an exact tracking rate for any part of the sky.

The Astro-Physics Command Center Pro (APCC) includes tracking and pointing correction based on calculations from atmospheric refraction all the way up to sophisticated real-world models based on plate-solve data for your specific instrument package.

**Initially, the mount was working fine. Then, suddenly the mount stopped tracking altogether !**

Chances are that the motor was turning properly and driving the worm gear, but that your clutches might have been loose and therefore the scope was not following the motion of the worm gear. The fact that the high slew rate did move the scope does not change this, because Roland has seen this himself where the tracking rate did not overcome the slipping clutches but the slew rate did.

If you are unsure of the motion of the motor, just remove the motor cover plate and look inside. You will see the motor turning. Sometimes when you have the clutches loosely engaged and the counterweights are somewhat out of balance, being heavy in the east, then the clutches might slip at the slow sidereal rate.

In any case, just to set your mind at ease, simply remove the motor cover next time something like this happens and look at the motor shaft. If the motor is not turning, you will have some kind of electrical problem. If it is turning, then it is mechanical.

**The motors sound louder and more labored in cold weather.**

As the temperature drops, we recommend that you reduce your slewing speed to the slowest slew rate. The cold causes the lubricants to get stiff in the gearboxes. This can make the high-speed gears resonate and sound screechy. Lowering the slew speed in winter will eliminate or reduce this. You might also want to add a drop or two of light machine oil to the center posts of the individual gears. Just remove the cover on the gearbox and add the oil drops. The noise is nothing to worry about. Refer to the section of this manual entitled: Slewing Your Mount in Below Freezing Temperatures.

**The declination axis does not appear to be moving properly. How can I check it?**

Please refer to the section of this manual entitled: “Characterizing the Dec. Axis Motions,” which explains how to use Diffraction Limited’s *Maxim DL*™ software to characterize your mount’s performance.

**When I press the E button on my keypad, it takes forever for the star to finally stop.**

First, the problem is most often caused by the worm and worm wheel not being in mesh (this is often the case when a used mount is purchased and the previous owner never ever adjusted the worm mesh or the mesh was altered during shipment). When the worm is out of mesh, it takes the motor many seconds to reverse the tooth contact from leading to trailing edge because it is running at the very slow sidereal rate. Backlash adjustment is very easy to accomplish on the 1600GTO that has the Auto Adjusting Motor Gearboxes. Please refer to the section in this manual entitled: “Gear Mesh in the 1600GTO”.

**I am experiencing trailed stars after a slew and apparently a high, variable backlash.**

Check to make sure that the spur gear that is attached to the end of the worm is not loose. A loose screw will indeed



cause the axis to delay during reversal. In a few cases, we have seen that the set screw on this spur has backed off and needs to be retightened. If you have any doubts about where this worm and spur gear is in the scheme of things, call Astro-Physics and we will talk you through the procedure to check this.

Remember this: Any backlash or looseness in Dec. will NOT cause trailed stars after a slew. That is because the Dec. axis does not move once it gets to its new position, so no trailing is possible. So, if you are getting trailed stars for a short time, don't look for something in the Dec. axis.

However, the R.A. Axis WILL cause trailed stars after a slew if the spur gear is loose. That is because this axis must move at the sidereal rate immediately after getting to the new position. If the spur gear is loose on the worm shaft, it will turn slowly at the sidereal rate without imparting this motion to the worm itself (because it is slipping). At some point, the set screw will catch on the edge of the flat on the worm shaft and begin to drive the worm gear. So, this looks like classical backlash, when in fact it is not backlash at all, and all attempts at setting the gear mesh on the worm are futile to correct this lost motion.

When we get a chance, we will post a complete set of pictures on our website showing how to check for this loose gear condition. Meanwhile, you can take the cover off the motor gearbox and acquaint yourself with the spur gears inside. Do not be afraid to move and wiggle things by hand to see how stuff works.

One more thing, sometimes a person will be absolutely certain that it is the Dec. axis that is giving him a problem because the CCD program he is using shows some improper function in the Y-axis, and he is absolutely certain that Y = Dec. After much sending of equipment back and forth to our facility, it finally is determined that it was the other axis after all that had the problem. PLEASE, please make sure that you have identified the proper axis. In the case of any kind of motion problem like this, it would be really helpful if you removed your camera, inserted an eyepiece with crosshairs and actually looked to see what was happening. You can then identify exactly which direction, R.A. or Dec., is moving after a slew. Sometimes because of mix-ups in the CCD software (*MaxImDL*<sup>™</sup>, for instance), the axes are identified backwards.

When you are trouble shooting, remember, R.A. is the only axis that must move at the sidereal rate and is the only axis that can trail a star if it is not moving correctly at that rate. The Dec. axis does not move after a slew and will not trail a star except by a very slow long period drift due to polar misalignment, etc. It will not trail a star image EVEN if it has 10 degrees of backlash, so that analysis is definitely suspect.

### **I'm having a frustrating guiding problem with my mount and need to figure out my next steps.**

To begin with, the directions represented by the X+, X-, Y+ and Y- in your guiding software do not necessarily correspond to any given cardinal directions. To the guiding software, "X" and "Y" simply refer to the rows and columns of pixels on the guide chip – nothing more.

The act of calibration tells the guiding software how to relate a guide star's drift along the columns and rows to move directions in the mount, but it does not make it so that X is necessarily always right ascension and Y always declination. To further complicate this, each time you alter the camera's orientation, you effectively change the relationship between X / Y and R.A. / Dec.

Your very first step in diagnosing any type of guiding problem should be to determine the actual current relationship between the X and Y of the guiding software and the R.A. and Dec. of your mount. This is easily done in your guiding software by making a manual move in one axis during an exposure and comparing this to a guide move from the keypad (use the keypad – not your computer software!) where you know the axis and direction for certain.

We have seen customers waste countless hours (not to mention dollars) in trying to fix a guiding problem on an axis that was performing perfectly. Meanwhile, their true problem remained, all because of this axis mix-up.

Your next step would be to remove the camera and place a high power eyepiece with crosshair reticle into the focuser. Then sit down and watch what happens to the guide star. With the eyepiece and reticle, you can see whether or not the mount is tracking smoothly and how the periodic error is manifesting itself. Yes, you will have periodic error, and any good CCD camera will pick it up to give you oval stars - that is a given. What you need to find out is whether this periodic error is within limits ( $\pm 3.5$  arcseconds for the 900GTO and 1100GTO and  $\pm 2.5$  arcseconds for the 1200GTO and 1600GTO) and whether it is smoothly varying. You can also do some hand guiding using the 4 buttons on the keypad. It will tell you how responsive the mount is to your guiding inputs and may even show some hidden problems when you try to keep the star on the crosshairs.

Alternately, you can use *PEMPro*<sup>™</sup> (the full version of *PEMPro*<sup>™</sup> is included with the 1600GTO) to characterize your periodic error. It will tell you things like the peak value and the smoothness of the error.

You can also characterize your mount tracking and guiding abilities using the "Characterizing the Dec. Motions" test outlined in the Technical Support section of our AP website and included in the back of this manual. Many times a problem guiding in R.A. can be the result of a Dec. axis mechanical problem. Not knowing this, you will be forever chasing down

the problem on the R.A. axis, and never reaching a solution. Characterizing your Dec. axis will at least show you that the mount reacts properly to the 4 guide directions. If it shows a problem area, then at least we will know how to fix it.

Once you know that the mount is tracking in a normal fashion with normal periodic error profile, you can go from there to begin setting up your guiding parameters. It is not a piece of cake to get an autoguider to work flawlessly. It is an art, but once you know that the mount responds properly to the guide inputs, it should be possible to set it up to work accurately.

## ***Additional Support***

For additional information regarding the 1600GTO, refer to the Technical Support Section of our website. We also encourage you to participate in the ap-gto Yahoo user group. The members of this group are very knowledgeable about the operation of their mounts, CCD imaging and other related issues. The staff of Astro-Physics also participates and you will find a wealth of information in the archives. To find the group, link from User Groups in our website's sidebar.

If any problems occur, please don't hesitate to contact Astro-Physics for assistance.

We encourage you to submit your technical support questions directly to Astro-Physics by phone or e-mail: [support@astro-physics.com](mailto:support@astro-physics.com).

We may add additional troubleshooting tips to future versions of this manual or in a separate technical document. In such an instance, we would add this information to the Technical Support section of our website as well.

**ASTRO-PHYSICS, INC**  
11250 Forest Hills Road  
Machesney Park, IL 61115  
Telephone: (815)-282-1513  
Fax: (815)-282-9847  
[support@astro-physics.com](mailto:support@astro-physics.com)  
[www.astro-physics.com](http://www.astro-physics.com)

# APPENDIX A: 1600GTO ABSOLUTE ENCODERS

The Absolute Encoder option for the 1600GTO mount can be installed at the factory before shipping or installed later by the user. It provides absolute positioning information, eliminates periodic error and eliminates Dec. backlash. The encoders provide the ultimate in mount perfection.

## Part numbers and description

### Standard Temperature Version:

- R.A. and Dec. Absolute Encoder and Readhead, standard temperature version, installed at Astro-Physics (16AE-4-I)
- R.A. and Dec. Absolute Encoder and Readhead Kit, standard temperature version, installed by customer (16AE-4-KIT)

### Low Temperature Version:

- R.A. and Dec. Absolute Encoder and Readhead, low temperature version, installed at Astro-Physics (16AE-4L-I)
- R.A. and Dec. Absolute Encoder and Readhead Kit, low temperature version, installed by customer (16AE-4L-KIT)

## What's Included in the Kit

- R.A. and Dec. RESA Ring Assemblies
- R.A. and Dec. Readhead Assemblies
- Cable from GTOCP4 Control Box to Interface at rear of the R.A. axis (CAB16AE)
- CD with Absolute Encoder Utility (APAE), version 2.0 or latest (Windows-based)
- All Required Fasteners

## Absolute Encoder Cable Connections

Complete information for installation and connection is provided in a separate instruction sheet included with the kit. Set up and use of the Absolute Encoders is found in the "Help" file menu of the APAE Utility that will need to be installed on your computer. Nevertheless, a brief mention and description is provided here.

There is only one external cable (CAB16AE) with its two connectors of which the user needs to be aware with factory installed encoders. This cable connects at the rear plate of the R.A. axis (slot screwdriver required) and runs to the Encoder connector on the GTOCP4 Control Box.

The two photos at the right identify both the Servo Motor cable and the Absolute Encoder cable and their respective connections.

If one orders the Absolute Encoder Kit to be installed on an existing mount, then each Readhead (R.A. and Dec.) will have internal connectors requiring a one-time connection. This will be described in full in the instruction guide that comes with the kit.

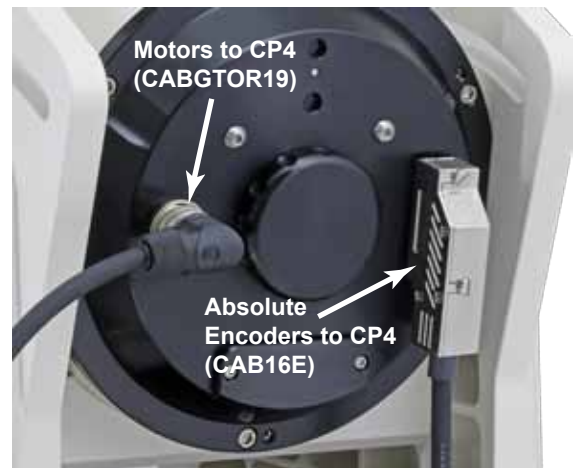

## APAE Utility

The APAE Utility is the stand-alone utility which is used to turn on/off the Absolute Encoders and to adjust the Home and Limits settings. This utility was provided to you when we shipped the mount. You must have the newest version to recognize the GTOCP4.

The APAE Utility needs to be connected to the GTOCP4 through a separate COM port from the one that is controlling the mount. This connection can be done through the GTOCP4's second RS-232 serial port or through the USB connection (which is another form of serial port). A straight-through serial cable was provided with the mount. You will need a second serial cable or a USB cable for the connection.

**Important:** You cannot use an APCC virtual port for this connection...it must be a real port!

The APAE Utility is issued on a CD that ships with the Absolute Encoder version of the mount and with the Absolute Encoder Kits. The utility is currently at version 2.0 or later. If you have an earlier version of the utility, you should update it to version 2.0 or later.



# APPENDIX B: DECLINATION AXIS BACKLASH TESTS

## PulseGuide™

PulseGuide™ is a free software program, developed by Ray Gralak, to provide keypad-like functionality using a computer. It offers the additional feature of a Dec. axis backlash test. You can download it through a link from the AP website.

Once you have started the PulseGuide™ application and have connected to the mount, go to the “PEM/other” tab and click the “Backlash Tests” button to bring up three tests suggested by Roland Christen to test the performance of your declination axis. Roland posted some tests that you can run on your AP mount to see if it has a potential problem with Dec movement.

**IMPORTANT: Before running tests 1 and 2 set the mount's backlash to 0. Also while performing the tests do not try to auto-guide.**

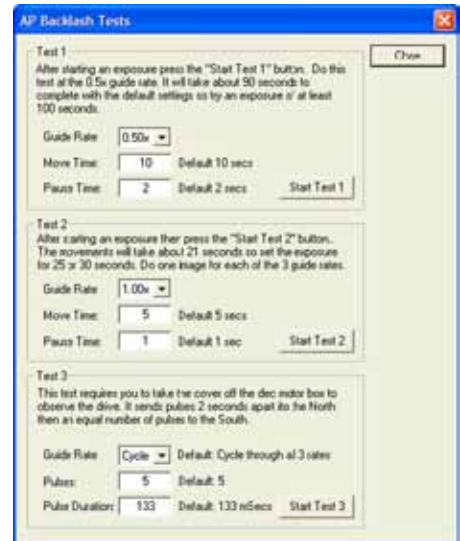

### Dec Backlash Test 1

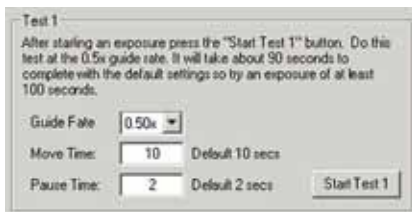

Before starting Test 1 set up your camera control program (e.g. *MaxImDL™*, *CCDOps™*, etc.) to do a 100 second exposure (but do not autoguide). You can also set up an auto-dark exposure, but make sure that you start the test when the camera control software is exposing the light image.



Once you start the exposure press the Start Test 1 button. With the default settings (recommended) the entire procedure will take about 90 seconds.

Test 1 will move the scope in this manner: East - pause - West - pause - East to center - North - pause - South - pause - North to center.

The stars in the resulting exposure should look something like the image to the right. The scale might be different but you should see what looks like many plus signs in the image.

If you take the image near Dec=0 the height and width will be about the same. Although not shown in this particular image the East and West points will be slightly brighter than the North/South points. This will make it easy for Roland to establish the orientation of the camera.

### Dec Backlash Test 2

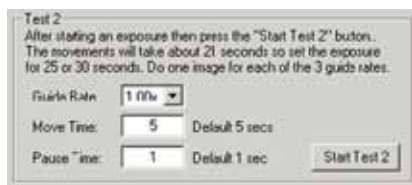

You will run Test 2 three times, once for each of the guide rates. Before starting this test set up your camera control program (e.g. *MaxImDL™*, *CCDOps™*, etc.) to do a 25 second exposure but do not try to autoguide. You can also set up an auto-dark exposure, but make sure that you start the test when the camera control software is exposing the light image.

Start by setting the Guide Rate to 1x. Once you start the exposure press the Start Test 2 button. With the default setting (recommended) the entire procedure will take about 16 seconds.

Although the scale might be different, the stars in the resulting exposure should look something like the image shown.

**0.5x**



For reference the actual movement in Test 2 is: North+West - South+West - West only (the pause setting) - North+West.

**0.25x**



Now you will need to repeat the tests at 0.50x and 0.25x. The star patterns will look similar but smaller because the movement rate is slower. Here are two examples taken with a Traveler:





## After Running Tests 1 and 2

If you see star patterns different from the above images then crop a bright star in each of the four images and save them as a high-quality JPEG. Please make sure to “stretch” each image appropriately so that it is not too dim or overexposed. If you do not know how to stretch and create a jpeg then save the cropped image in FITS format.

Then send the 4 files (preferably zipped to save bandwidth) to Roland at: [chris1011@aol.com](mailto:chris1011@aol.com).

After submitting these tests, AP will advise you if anything appears anomalous and if so what can be done about it.

## Dec Backlash Test 3

This test moves the declination motor at regular intervals to check that the gears move properly.

To do this test you will need to remove the cover from the declination motor housing (contact Astro-Physics for directions if you need).

The Guide Rate combo-box has 4 choices: 0.25x, 0.50x, 1.00x, and Cycle. You can choose a specific rate or Cycle to have *PulseGuide*™ repeat the test at each rate.

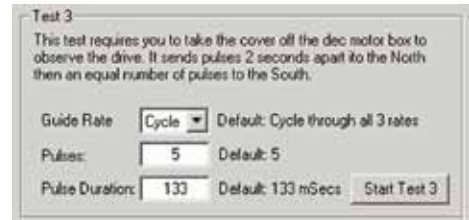

While watching the uncovered declination gears click the Start Test 3 button. *PulseGuide*™ will send 5 pulses spaced 2 seconds apart (or however many you entered in the Pulses edit box). Each pulse will of the same duration – that which you enter in the Pulse Duration edit box. The default is 133 milliseconds. Watch carefully to make sure the pulses look evenly timed and that the fastest moving gear moves equally each time.

Once all pulses have been sent in one direction, an equal number of pulses are sent in the reverse direction. It is normal on reversal of direction that there is a slight delay in movement because of backlash. If this happens you may wish to increase the pulse count. If you see erratic movement please contact Astro-Physics for instructions.

## MaxImDL™

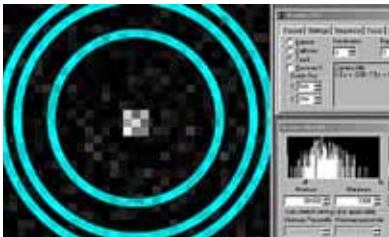

### Step 1

Acquire a reasonably bright guide star and begin guiding in R.A. only - turn off Dec. guiding. Use a 1 second or faster refresh rate so you can see the motion of the guide star as you begin to move it around. Magnify the screen to 1600x and place the cursor in the middle as shown. Check to make sure that the mount is guiding adequately in R.A. and that the guide star is not bouncing around due to poor seeing. Best results will be achieved when the R.A. guiding is 0.5 pixels average in R.A.

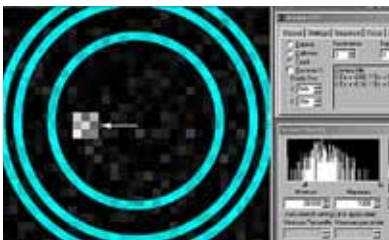

### Step 2

Put the keypad button rate at 0.5x. Press the keypad North button until the guide star has moved approximately 6 pixels from the center. Now press the South button in very short pulses and note which direction the star moves. It should move back toward the middle after a few button presses. It might move slightly up or down, or it might continue to move further away from the middle, or any combination. Please note exactly how far, and in which direction, the guide star moves (pixel position is displayed in the guide box at right in Maxim).

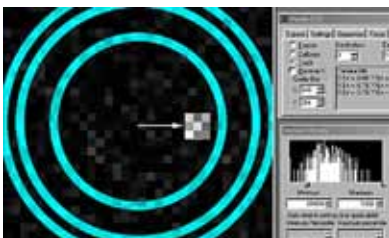

### Step 3

Press the South keypad button until the star has moved 6 pixels off the center in the opposite direction. Repeat Step 2 and note exactly the motion of the guide star as you move it with the pulsed motion at 0.5x.

You may wish to enable Track Log to record the numbers for further study. Please note on the log what you did at what time so the results will be useful later.

# APPENDIX C: MOUNTING PLATE FASTENER CHART

A-P Part #	Description	Ships with:
<b>FP1500</b>	15" Flat Plate	(4) 1/4-20x5/8" SHCS [for mounting to 400, 900 or Mach1GTO] (4) M6-1.0x20mm SHCS [for mounting to 600E] (4) 1/4-20x3/4" SHCS [for mounting to 1100GTO, 1200, & 1600GTO]
<b>FP1800</b>	18" Flat Plate	(6) 1/4-20x1" FHSCS [for mounting to 900, 1100GTO, 1200 or 1600GTO] (4) 1/4-20x1-1/4" FHSCS [Mach1GTO]
<b>DOVE08</b>	8" Dovetail Plate	(4) 1/4-20x1/2" SHCS [for mounting to 400] (4) M6-1.0x16mm FHSCS [for mounting to 600E] (4) 1/4-20x5/8" SHCS [for mounting to 900, 1100GTO or Mach1GTO, requires Q4047 or to attach to SBD13SS or SBD16SS] (4) 10-32x3/4" SHCS [for mounting as Accessory Plate onto A-P rings]
<b>DOVE15</b>	15" Dovetail Plate	(4) 1/4-20x1/2" FHSCS [for mounting to 400 or Mach1GTO] (4) M6-1.0x16mm FHSCS [for mounting to 600E] (4) 1/4-20x5/8" FHSCS [for mounting to 900, 1100GTO, 1200 or 1600GTO] (4) 10-32x3/4" SHCS [for mounting as Accessory Plate onto A-P rings]
<b>DOVELM2</b>	8.5" Dovetail Plate for Losmandy D Series Plate	(4) 1/4-20x5/8" SHCS [for mounting 400 or Mach1GTO] (4) M6-1.0x20mm SHCS [for mounting 600E] (2) 1/4-20x5/8" FHSCS [for mounting to 1200] ** (4) 1/4-20x3/4" SHCS [for mounting to 900, 1100GTO, 1200 or 1600GTO] ** [or to attach to SBD13SS or SBD16SS]
<b>DOVELM162</b>	16" Dovetail Plate for Losmandy D Series Plate for 900, 1200, Mach1GTO. Also for 3600GTO w/ SB3622 or SB3627 Can also be mounted on AP ring tops with blocks	(6) 1/4-20x1" SHCS [for mounting to 900, 1100GTO, 1200, 1600GTO or Mach1GTO (M1 uses 4), or to attach to SBD13SS or SBD16SS] (1) 1/4-20x3/4" FHSCS [opt. 900, 1100, 1200 or 1600 for end positions] (4) 1/4-20x3/4" SHCS [for SB3622 in side-by-side configuration and for attachment to blocks for ring-top mounting]
<b>900RP</b>	15" Ribbed Plate for 900 or Mach1GTO	(6) 1/4-20x1" FHSCS [for mounting to 900 or 1100GTO] (4) 1/4-20x1-1/4" FHSCS [for mounting Mach1GTO]
<b>1200RP15</b>	15" Ribbed Plate for 1200	(6) 1/4-20x3/4" SHCS [for mounting to 1200 or 1600GTO]
<b>1200RP</b>	24" Ribbed Plate for 1200	(6) 1/4-20x1" SHCS [for mounting to 1200 or 1600GTO]
<b>Q4047</b>	900/Mach1GTO Adapter for use with DOVE08	(6) 1/4-20x5/8" FHSCS [for mounting to 900 or 1100GTO] (4) 1/4-20x1" FHSCS [for mounting to Mach1GTO]
<b>SB0800 OR SB1000 OR SB1500</b>	7" and 10" Sliding Bars for DOVE08 or ACPLTR and 15" Sliding Bar for DOVE15	(2) 1/4-20x1/2" SHCS (2) Acorn Nuts (2) 1/4-20 Nuts (2) 1/4-20x3/8" SHCS (1) 10-32x5/8" FHSCS (1) 10-32 Nut
<b>SBD12</b>	12" Sliding Bar for the Losmandy D-Series Dovetail Saddle Plates	(4) 1/4-20x1" low profile SHCS [for attaching the SBDAPB or LMABLOCKS] (4) 1/4-20x1-1/4" FHCS [for attaching directly to AP Rings] (2) 1/4-20x1/2" SHCS [for center hole in rings] (4) 1/4-20x1/2" low profile SHCS (3) 1/4-20x3/8" SHCS [2 for Stowaway - 1 for Safety Stop] (2) 1/4-20x7/8" SHCS [Stowaway with SB0550 as spacer]
<b>SBD16</b>	16" x 5" Wide Sliding Bar for the Losmandy D-Series Dovetail Saddle Plates	(4) 1/4-20x3/4" SHCS [for attaching the SBDAPB or LMABLOCKS] (4) 1/4-20x1-1/4" FHCS [for attaching directly to AP Rings] (1) 1/4-20x3/8" SHCS [for Safety Stop] (4) 1/4" Flat Washers [for DOVELM16 & DOVELM16S knobs]
<b>SBDAPB</b>	AP Riser / Spacer Blocks	(4) #10-32 x 1/2" SHCS [for attaching to mounting ring tops] (2) 1/4-20x1/2" SHCS
<b>SBDTB</b>	Adapter Blocks for large Taks - Mewlon, BRC & FRC	(4) M10 x 20 mm SHCS [for attaching to SBD16]
<b>SBD13SS OR SBD16SS</b>	13" or 16" Side-by-side Dovetail Plate for Losmandy D-Series Dovetail Saddle Plates	(2) 1/4-20x3/8" SHCS [for Safety Stops -required at both ends]
<b>SBD2V</b>	12" Losmandy D-Series Male to Vixen Style (Losmandy V-Series) Female Adapter / Sliding Bar	(1) 1/4-20x1/4" low profile SHCS [to replace Safety Stop on V plate] (1) 1/4-20x1/4" SHCS [Safety Stop for SBD2V]
<b>LT2APM</b>	Losmandy Tripod to Astro-Physics Mount Adapter Plate	(3) 5/16-18x5/8" SHCS (4) 1/4-20x5/8" SHCS (4) 1/4-20x1" SHCS (3) 3/8-16x3/4 SHCS
<b>CBAPT, TRAYSB &amp; TRAYSB1</b>	Control Box Adapter, Bi-Level Support Bar & Single Level Support Bar	(1) 1/4-20x3/4" FHSCS (1) 1/4-20x1" FHSCS (1) 5/16-18x1" BHSCS (2) 5/16-18x3/4" BHSCS
<b>DOVEPW</b>	16.5" Dovetail Saddle for Planewave 7.652" dovetail on AP 1200, 1600GTO and 3600GTO	(6) 3/8-16x1" SHCS (6) 1/4-20x1" SHCS
<b>SBPW23</b>	23" P-Style Dovetail Plate for DOVEPW	(2) 3/8-16x1/2" low profile SHCS (4) 1/4-20x5/8" SHCS
<b>DOVE3622</b>	22" Dovetail Saddle Plate for 3600GTO	(6) 3/8-16x1" SHCS (4) 3/8-16x1-1/2" SHCS
<b>SB3622 OR SB3627</b>	Dovetail Sliding Bar for DOVE3622	(2) 3/8-16x1/2" low profile SHCS (4) 1/4-20x7/8" SHCS for lock-down

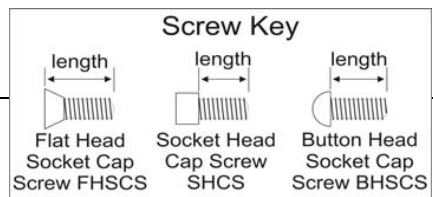

\*\* DOVELM2 may also be attached to 900 mount with (1) 1/4-20x5/8" FHSCS and (1) 1/4-20x3/4 SHCS